

# **INTERIORS**

**Caimi**

**INTERIORS**   
**Caimi**

**Office, Home & Contract Solutions**

**Furniture systems**  
p. 6



SOCRATE  
Outdoor  
p. 6

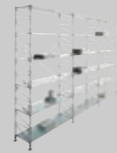

SOCRATE  
p. 30



BIG  
p. 66

**Public seating**  
p. 134

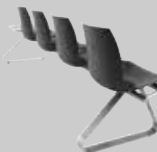

KALEIDOS  
Beam  
p. 136



ULISSE  
p. 140



ULISSE  
Inox  
p. 148

**Tables & Seating**  
p. 86



PEGASO  
p. 88



PEGASO  
Infinito  
p. 96



PEGASO  
Cemento/Solid/Metal  
p. 100



NEWTON  
p. 114



CICERONE  
p. 118



JOLLY  
p. 120



KALEIDOS  
p. 122



KALEIDOS  
Fabric  
p. 128



KALEIDOS  
Stool  
p. 130

**Dividers & Partitions**  
p. 152



ARIANNA  
p. 154

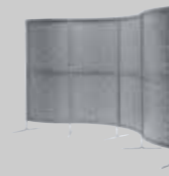

ARCHIMEDE  
p. 164



BATTISTA  
Divider  
p. 170



SEPÀ ROLLS  
Safety  
p. 172



SPEECH  
Divider  
p. 174



ARIANNA  
Desk  
p. 176



GEKO  
p. 178

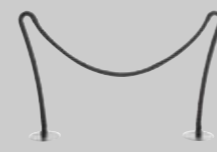

GASTONE  
p. 180



BATTISTA  
Stanchion  
p. 184



SET  
p. 188



SPEECH  
Barrier  
p. 194

**Communication & Meeting**  
p. 196

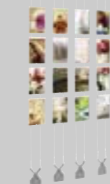

KOALA  
p. 198



KOALA-T  
p. 204



ARCHIMEDE DISPLAY  
p. 208



SET  
p. 210



BATTISTA  
Totem  
p. 211

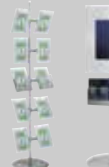

KOALA  
Totem  
p. 212



MEETING  
p. 214



SPEECH  
p. 218

**Accessories**  
p. 226



MET'ALL  
p. 228



SWING  
p. 232



QUADRANGOLO  
p. 236



GIOIA  
p. 238



ELK  
p. 239



EVA  
p. 240



KING  
p. 241



MAESTRALE  
p. 242



BATTISTA  
Color  
p. 244



BATTISTA  
p. 248



SWING  
p. 254



HOOK  
p. 257



PEDONE  
p. 258



AMANITA  
p. 258



DUO  
p. 259

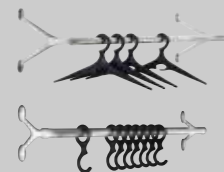

AMBROGIO  
AMBROGINO  
p. 260



OMETTO  
p. 262



HANGER  
p. 262

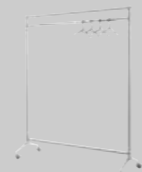

ARCHISTAND  
p. 264



SPEECH  
Stander  
p. 265

**Accessories**  
p. 226



SWING  
p. 266



HI-TECH  
p. 268



DIVIDO  
p. 271



DESIGN COLLECTION  
p. 272



HI-TECH  
p. 274



PIOGGIA  
p. 276



SET  
p. 277



KABO  
p. 277

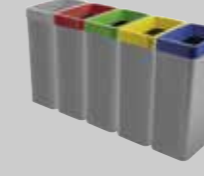

MAXI  
p. 278



CENTOLITRI  
p. 280



MAXIMO  
p. 282



PRISMA  
p. 284



SMILE  
p. 288



TORRE  
p. 289



EXTERNO  
p. 290



PIAZZA  
p. 291



OREDODICI  
p. 293



BISS  
p. 294



UP  
p. 294



BELT  
p. 295



HI-TECH  
p. 295

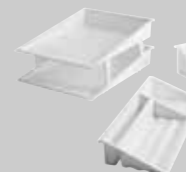

DESK-UP  
p. 296



PLAT  
p. 298



KABO  
p. 300

# SOCRATE Outdoor

design Mario Trimarchi  
Caimi Lab

**I**\_Socrate Outdoor è un sistema d'arredo per esterno, modulare e componibile, pensato come un elemento polivalente dotato di accessori che lo rendono funzionale per svariati utilizzi outdoor, per piccoli e grandi spazi. Composto da una struttura base fatta di montanti, crociere e griglie, realizzati in tondino di acciaio zincato e verniciato e da ripiani in metallo, in marmo, piani portavasi, griglie e contenitori realizzati in acciaio inox o zincato e verniciato. I differenti colori di strutture, ripiani e accessori possono essere combinati fra loro per un inedito effetto cromatico.

**EN**\_Socrate Outdoor refers to a system of modular outdoor furniture. Socrate Outdoor items are designed to be multifunctional and come equipped with accessories for adapting them to any one of the various uses to which they can be put in a given place, be it small or large. Each item in the range consists of a basic frame of uprights, bracing crosses and grids of galvanized and coated steel that support metal or marble shelves, planter holders, meshes and containers made either of stainless steel or of powder-coated galvanized steel. Available in a variety of colours, the basic structures, shelves and accessories can be mixed and matched to achieve a personalized chromatic effect.

**F**\_Socrate Outdoor est un système de mobilier d'extérieur, modulaire et assemblable, conçu comme un élément polyvalent avec des accessoires qui le rendent apte à diverses utilisations en extérieur, pour des espaces petits ou grands. Il se compose d'une structure de base comprenant des montants, des croisillons et grilles en tige d'acier galvanisé peint et des étagères en métal, en marbre, des tablettes porte-pots, des grilles et des récipients en acier inoxydable ou galvanisé et peint. Les différentes couleurs des structures, étagères et accessoires peuvent être assemblées entre elles pour obtenir un effet chromatique inédit.

**D**\_Socrate Outdoor ist ein modulares Einrichtungssystem aus kombinierbaren Elementen für den Außenbereich. Es basiert auf dem Konzept eines durch Zubehör großen oder kleinen Räumen sowie verschiedenen Außenraum-Funktionen anpassbaren Mehrzweckelementes. Die Grundstruktur sieht Ständer, Kreuzelemente und Gitterelemente aus verzinktem und lackiertem Stahlrohr sowie Regalböden aus Metall und Marmor, Pflanzenablageflächen, Gitter und Behälter aus rostfreiem bzw. verzinktem und lackiertem Stahl vor. Die unterschiedlichen Farben der Strukturelemente, Regalböden und Zubehörelemente können miteinander kombiniert werden, um überraschende Farbeffekte zu erzielen.

**E**\_Socrate Outdoor es un sistema modular de decoración para exteriores, concebido como elemento versátil que incorpora diversos accesorios para resultar más funcional a los diferentes espacios, tanto de pequeño como de gran tamaño. Consta de una estructura básica con montantes, crucetas y rejillas de acero galvanizado y pintado y de estantes de metal, mármol, repisas porta macetas, rejillas y contenedores de acero inoxidable o galvanizado y pintado. Se pueden combinar los diferentes colores de las estructuras, estantes y accesorios para conseguir un efecto cromático original.























**SOCRATE Outdoor - Dimensions in cm**

**I**\_Montanti, crociere e schienali realizzati in acciaio zincato e verniciato con polveri epossidiche per esterni.

**EN**\_Uprights, cross bars and back panels in galvanized steel and epoxy powder-coated for outdoor use.

**F**\_Montants, croisillons et fonds en acier galvanisé et peint en époxy pour l'extérieur.

**D**\_Seitenteile, Stabilisierungskreuze und Rückwände verfügbar in verzinktem bzw. pulverbeschichtetem Stahl für die Verwendung im Außenbereich.

**E**\_Montantes, crucetas y traseras en acero galvanizado y pintado con polvos epoxi para uso exterior.

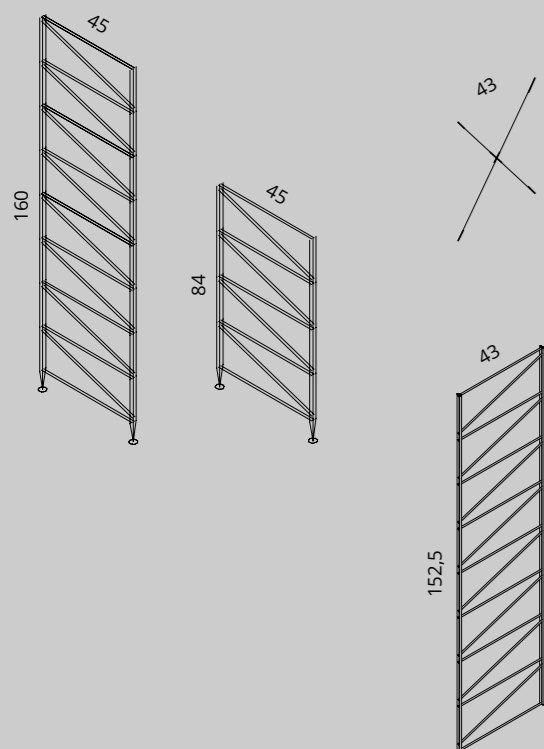

**I**\_Ripiani in lamiera o in filo di acciaio realizzati in acciaio zincato e verniciato con polveri epossidiche per esterni.

**EN**\_Shelves in metal sheet or steel wire in galvanized steel and epoxy powder-coated for outdoor use.

**F**\_Étagères en tôle ou fil d'acier en acier galvanisé et peint en époxy pour l'extérieur.

**D**\_Fachböden massiv oder aus Stahldraht verfügbar in verzinktem bzw. pulverbeschichtetem Stahl für die Verwendung im Außenbereich.

**E**\_Estantes en chapa o en malla de acero en acero galvanizado y pintado con polvos epoxi para uso exterior.

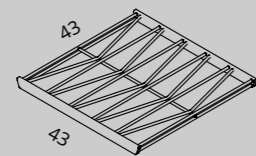
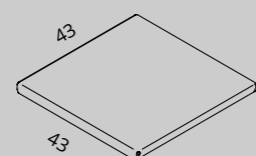

**I**\_Ripiani stagni, vaschette e mensole realizzati in acciaio zincato e verniciato con polveri epossidiche per esterni.

**EN**\_Tray and Watertight shelves in galvanized steel and epoxy powder-coated for outdoor use.

**F**\_Étagères étanches, bacs et tablettes en acier galvanisé et peint en époxy pour l'extérieur.

**D**\_Wasserundurchlässige Trays und Fachböden verfügbar in verzinktem bzw. pulverbeschichtetem Stahl für die Verwendung im Außenbereich.

**E**\_Baldas estancas, bandejas y estantes en acero galvanizado y pintado con polvos epoxi para uso exterior.

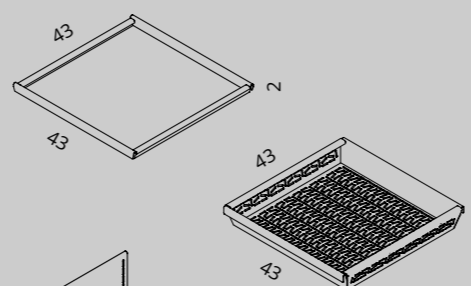

**I**\_Ripiani in granito Serizzo o in marmo di Carrara completi di sottopiano in acciaio zincato e verniciato con polveri epossidiche per esterni.

**EN**\_Serizzo granite or Carrara marble shelves with undercounter in galvanized steel and epoxy powder-coated for outdoor use.

**F**\_Étagères en granit Serizzo ou en marbre de Carrare avec sous-plan en acier galvanisé et peint en époxy pour l'extérieur.

**D**\_Fachböden aus Serizzo Granit oder Carrara Marmor mit Unterseite aus verzinktem bzw. pulverbeschichtetem Stahl für die Verwendung im Außenbereich.

**E**\_Estantes de granito Serizzo o en mármol de Carrara que se completan con estructura en acero galvanizado y pintado con polvos epoxi para uso exterior.

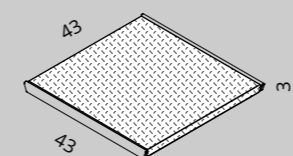

**I**\_Contenitore in acciaio inox con ruote.

**EN**\_Stainless steel container with wheels.

**F**\_Réceptier en acier inox avec roues.

**D**\_Edelstahl-Container auf Rollen.

**E**\_Recipiente de acero inoxidable con ruedas.

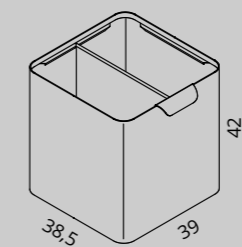

**SOCRATE Outdoor - Dimensions in cm**

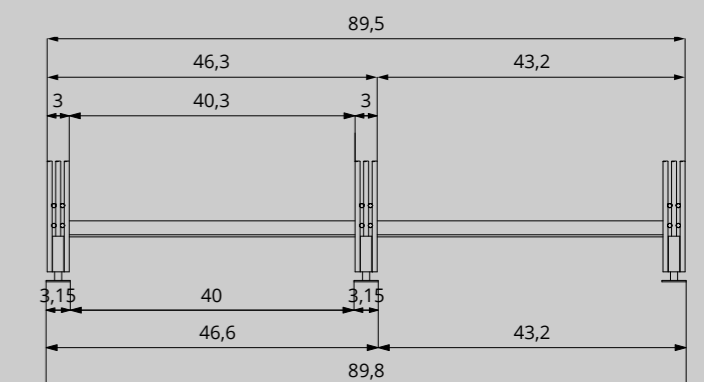
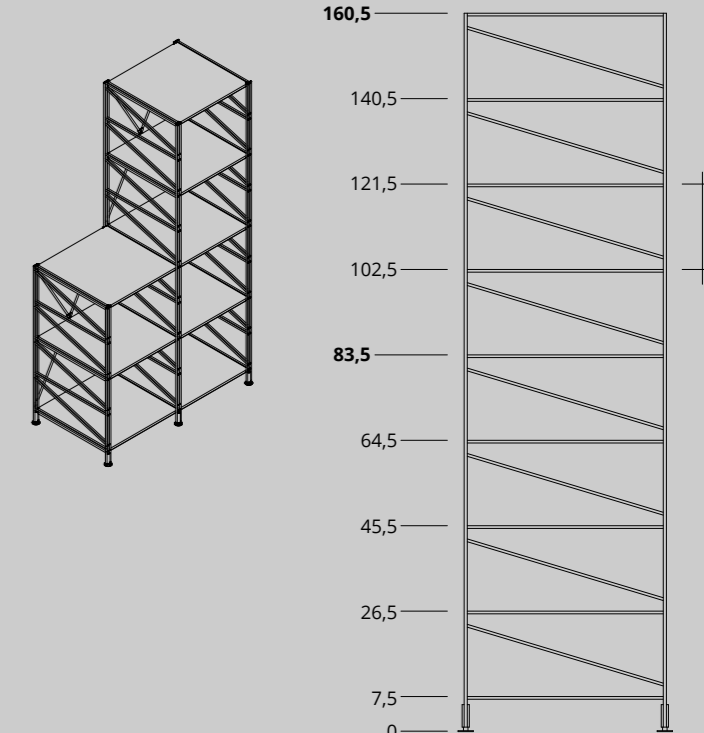













**I**\_Teli posteriori realizzati in tessuto fonoassorbente Snowsound Fiber Textiles.

**EN**\_Back sheets made of Snowsound Fiber Textiles, a sound-absorbing fabric.

**F**\_Des toiles de fond réalisées en tissu phono-absorbant Snowsound Fiber Textiles.

**D**\_Leinwand-Rücken aus schalldämpfendem Snowsound-Fiber-Textil-Gewebe.

**E**\_Parte posterior de tejido fonoabsorbente Snowsound Fiber Textiles.



**SOUND ABSORBING  
TEXTILE**









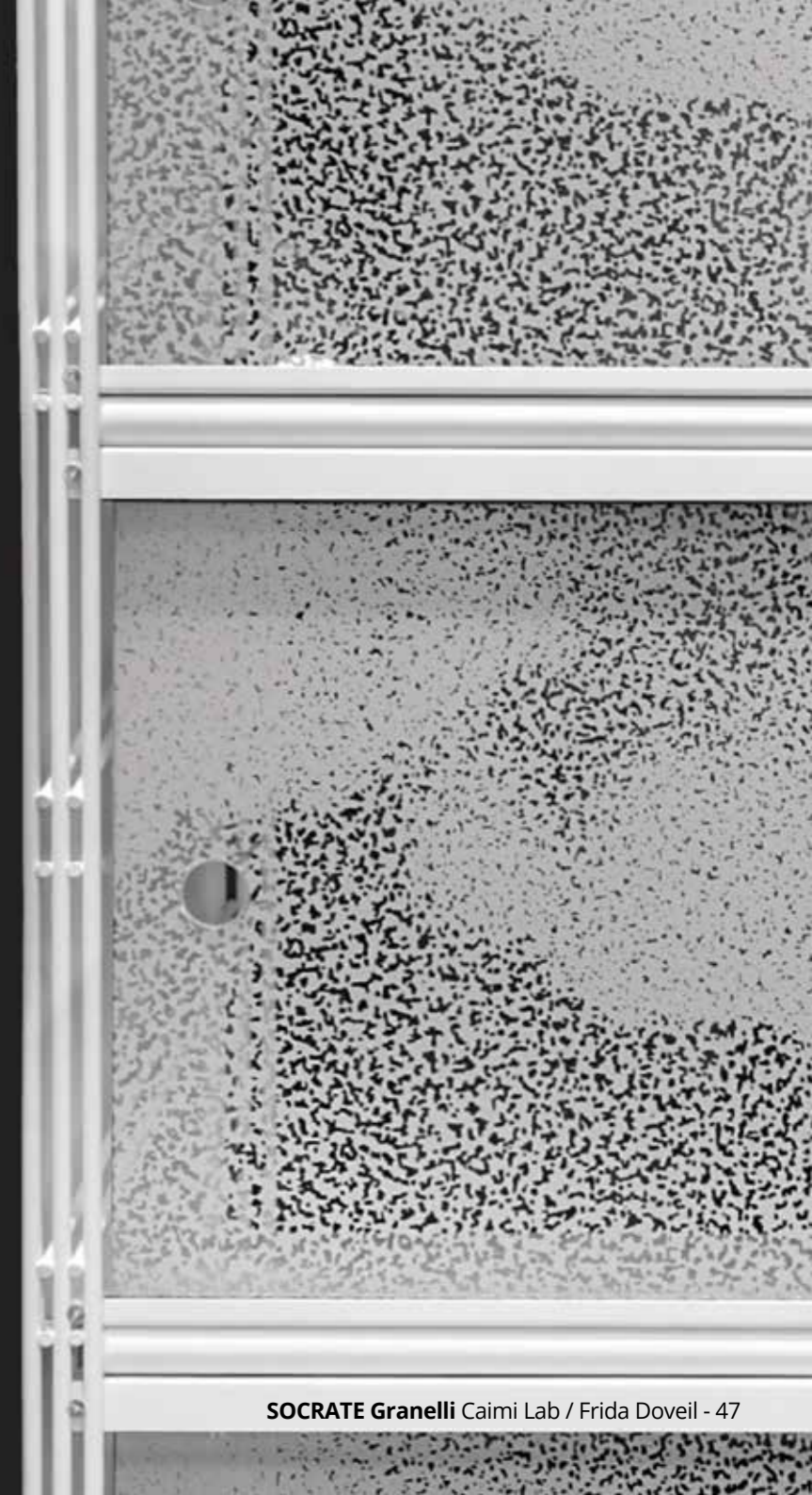
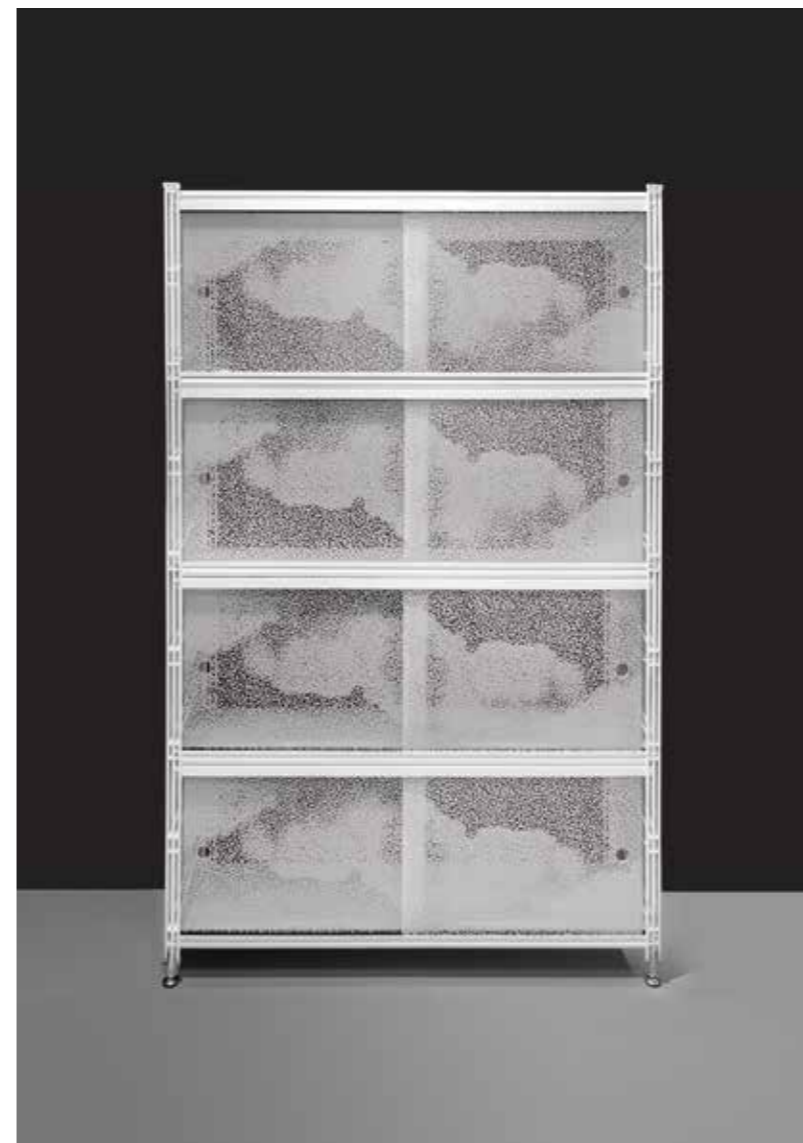











**I** Espositore a tre ante in metacrilato con struttura di sostegno in acciaio cromato e verniciato.

**EN** Three-flap panels display unit in methacrylate with supporting structure in chrome-plated and epoxy powder-coated steel.

**F** Présentoir à trois volets en méthacrylate avec support en acier chromé et peint.

**D** Aussteller mit drei Türen aus Methacrylat mit Stützstruktur aus verchromtem und beschichtetem Stahl.

**E** Expositor de tres puertas de metacrilato con estructura de apoyo de acero cromado y pintado.



# SOCRATE Bibliotech

Caimi Lab

**I** I ripiani in acciaio pieno o microforato sono realizzati con bordo frontale a doppio spessore arrotondato anti-infortunio. La piegatura laterale permette l'aggancio diretto al montante. I ripiani microforati facilitano la circolazione dell'aria migliorando l'aerazione dei libri e riducendo quindi la pericolosa formazione di umidità.

**EN** The shelves, in solid or microperforated steel, feature a rounded, accident-preventing, double thickness, front edge. The side fold allows the direct link to the upright. The microperforated shelves make the air circulation easier, thus improving the ventilation of books and reducing the dangerous formation of humidity.

**F** Les tablettes en acier, plein ou microperforé, sont réalisées avec rebord frontal à double épaisseur avec arrondi de sécurité. Le pliage latéral permet de les fixer directement au montant. Les tablettes microperforées facilitent l'aération des livres et réduisent le risque d'humidité.

**D** Die Regalböden, aus glattem oder microperforiertem Stahl, verfügen über einen abgerundeten verletzungs-sicheren verstärkten Vorderrand. Die seitlichen Abkantungen ermöglicht das direkte Einhängen in den Ständern. Die Regalböden mit Microperforation erleichtern die Luftzirkulation und verbessern die Belüftung der Bücher, wodurch gefährliche Feuchtigkeitsbildung verringert wird.

**E** Los estantes de acero tienen un borde en la parte anterior de doble espesor redondeado anti-caída. El dobléz lateral permite engancharlos directamente al montante. Los estantes microperforados facilitan la circulación del aire mejorando la aireación de los libros reduciendo así la peligrosa formación de humedad.

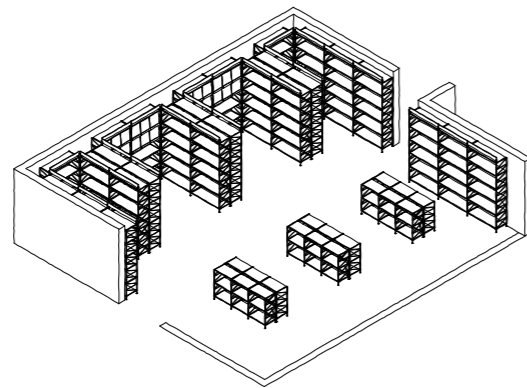



**I**\_Montanti, crociere e schienalini disponibili in acciaio cromato o verniciato con polveri epossidiche colore bianco opaco, grigio metallizzato o nero. Schienali in acciaio pieno verniciati con polveri epossidiche colore bianco opaco, grigio metallizzato o nero.

**EN**\_Uprights, bracing crosses and back panels in chrome-plated or epoxy powder-coated steel, mat white, metal grey or black. Backs in solid epoxy powder-coated steel, mat white, metal grey or black.

**F**\_Montants, croisillons et raidisseurs disponibles en acier chromé ou peint époxy blanc mat, gris métallisé ou noir. Dossiers en acier plein peint époxy, blanc mat, gris métallisé ou noir.

**D**\_Seitenteile, Kreuze und Rückwände erhältlich aus verchromtem oder mit Epoxypulver beschichtetem Stahl, in den Farben mattweiß, grau metallic oder schwarz. Rückwände aus Vollstahl, mit Epoxypulver beschichtet in den Farben mattweiß, grau metallic oder schwarz.

**E**\_Laterlaes, soportes traseros y pequeños respaldos disponibles en acero cromado o pintado con polvo epoxi color blanco mate, gris metalizado o negro. Respaldos de acero compacto pintado con polvo epoxi color blanco mate, gris metalizado o negro.

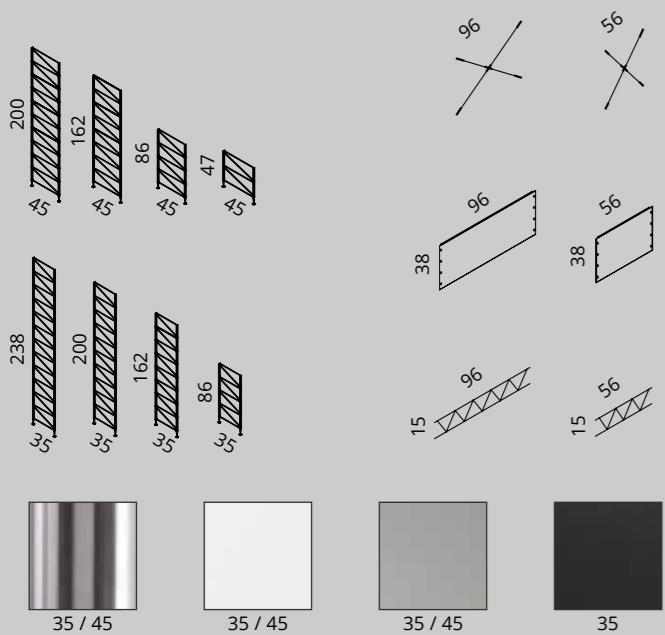

**I**\_Ripiani in vetro temperato trasparente o in acciaio pieno o microforato, verniciati con polveri epossidiche colore bianco opaco, grigio metallizzato o nero, disponibili con o senza bordo rialzato posteriore.

**EN**\_Shelves in transparent tempered glass or in solid/micro-perforated epoxy powder-coated steel, matt white, metal grey or black, available with or without rear raised edge.

**F**\_Tablettes en verre trempé transparent ou en acier plein ou micro-perforé peint en époxy blanc mat, gris métallisé ou noir, disponibles avec ou sans rebord postérieur surélevé.

**D**\_Regalböden aus gehärtetem Glas oder Vollstahl oder mikroperforiertem Stahl, mit Epoxypulver beschichtet in den Farben mattweiß, grau metallic oder schwarz, mit oder ohne erhöhter Hinterkante erhältlich.

**E**\_Estantes de vidrio templado transparente o de acero de alma llena o perforado, pintados con polvos epoxi blanco mate, gris metalizado o negro, disponibles con o sin borde posterior en relieve.

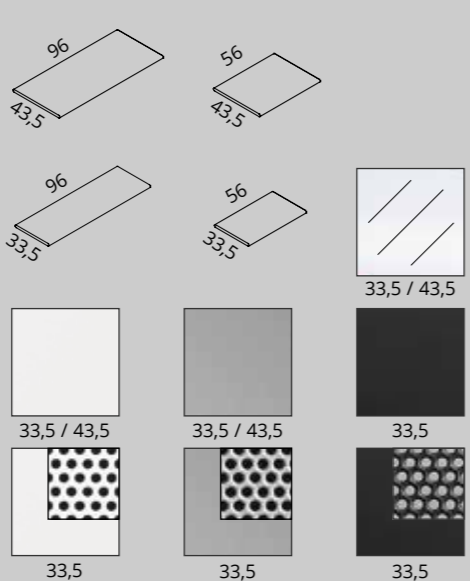

**I**\_Ripiani/espositori inclinati in acciaio microforato verniciato con polveri epossidiche colore bianco opaco, grigio metallizzato o nero.

**EN**\_Sloped shelves/display units in epoxy powder-coated micro-perforated steel, matt white, metal grey or black.

**F**\_Présentoirs inclinés en acier micro-perforé peint en époxy, blanc mat, gris métallisé ou noir.

**D**\_Schrägausstellungstablare/-regalfächer aus mit Epoxypulver beschichtetem Stahl, mattweiß, grau metallic oder schwarz.

**E**\_Estantes expositores inclinados en acero pintado con polvo epoxi, blanco mate, gris metalizado o negro.

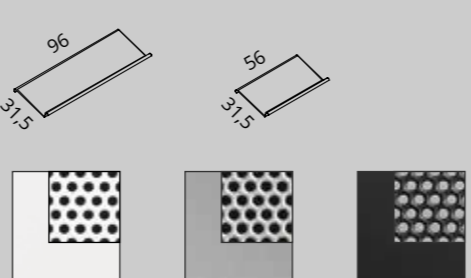

**I**\_Chiusure laterali in acciaio pieno verniciato con polveri epossidiche colore bianco opaco, grigio metallizzato o nero.

**EN**\_Side closures in epoxy powder-coated solid steel, mat white, metal grey or black.

**F**\_Fermetures latérales en acier plein peint époxy blanc mat, gris métallisé ou noir.

**D**\_Seitenteile aus Epoxypulver beschichtetem Stahl in den Farben mattweiß, grau metallic oder schwarz.

**E**\_Cierres laterales de acero compacto pintado con polvos epoxi color blanco mate, gris metalizado o negro.

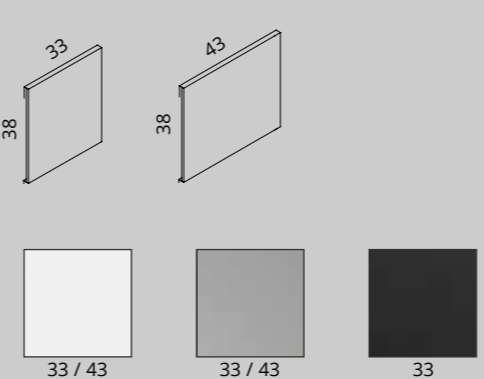

**I**\_Chiusure scorrevoli disponibili in acciaio verniciato con polveri epossidiche, in MDF placcato alluminio impiallacciato legno oppure in vetro satinato, trasparente o trasparente serigrafato. Guide in acciaio verniciato con polveri epossidiche.

**EN**\_The sliding closings come in epoxy powder-coated steel, in MDF (aluminum plated wood veneered), satin glass, transparent glass and screen-printed transparent glass. Guides are available in epoxy powder-coated steel.

**F**\_Les fermetures coulissantes existent en acier peint avec des poudres époxy, en MDF plaqué aluminium avec placage bois ou en verre satiné, transparent ou sérigraphié transparent. Glissières en acier peint avec des poudres époxy.

**D**\_Schiebetüren sind aus epoxidstaublackiertem Stahl, aus MDF mit Aluminiumüberzug, aus holzbeschichtetem MDF oder aus mattiertem Glas (durchsichtig mit oder ohne Siebdruck) erhältlich. Schienen aus epoxidstaublackiertem Stahl.

**E**\_Puertas correderas de acero pintado con polvos epoxi, MDF revestido de aluminio, enchapado de madera o vidrio satinado, transparente o transparente serigrafiado. Guías de acero pintado con polvos epoxi.

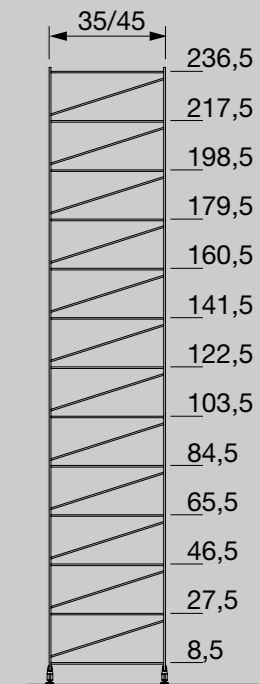
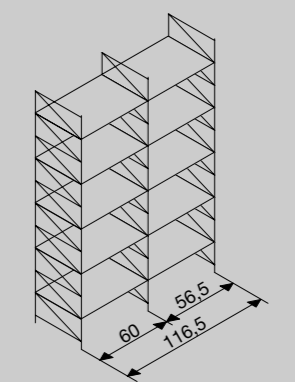
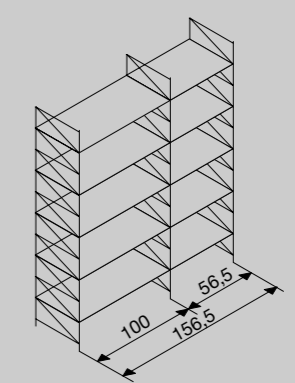
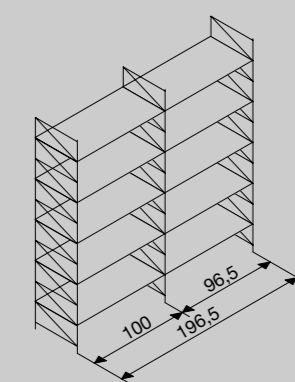
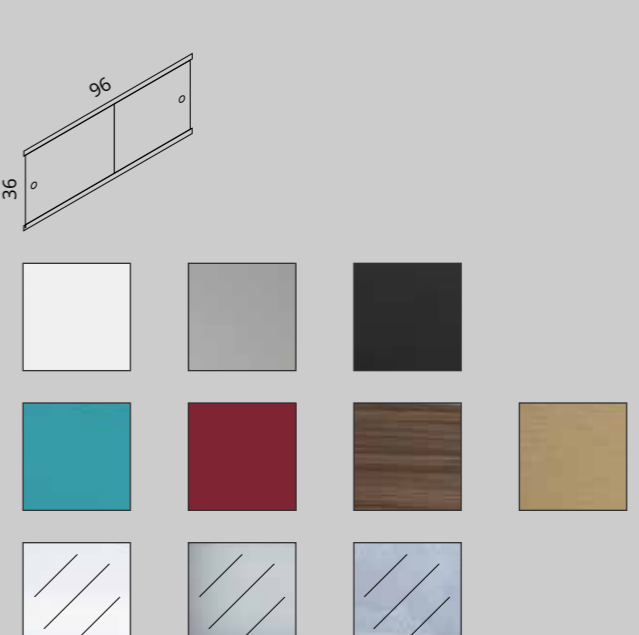

## SOCRATE Wall - Dimensions in cm

**I**\_Montanti e supporti disponibili in acciaio verniciato con polveri epossidiche colore bianco opaco o grigio metallizzato.

**EN**\_Uprights and supports in epoxy powder-coated steel, mat white or metal grey.

**F**\_Montants et supports disponibles en acier peint époxy blanc mat ou gris métallisé.

**D**\_Seitenteile und Halterungen aus Epoxypulver beschichtetem Stahl, in den Farben mattweiß oder grau metallisch.

**E**\_Laterlaes y soportes disponibles en acero pintado con polvos epoxi color blanco mate o gris metalizado.

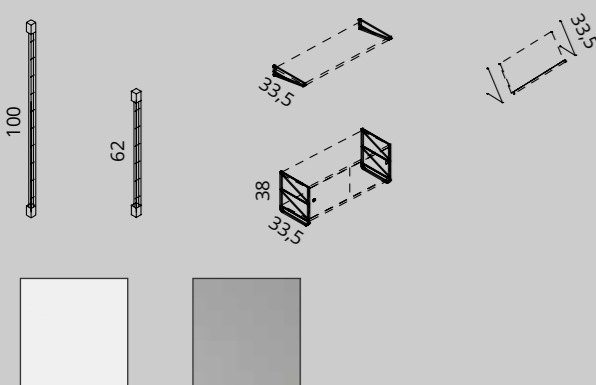

**I**\_Ripiani in vetro temperato trasparente o in acciaio pieno o microforato, verniciati con polveri epossidiche colore bianco opaco o grigio metallizzato.

**EN**\_Shelves in transparent tempered glass or in solid/micro-perforated epoxy powder-coated steel, matt white or metal gray.

**F**\_Tablettes en verre trempé transparent ou en acier plein ou micro-perforé peint en époxy blanc mat ou gris métallisé.

**D**\_Regalböden aus gehärtetem Glas oder Vollstahl oder mikroperforiertem Stahl, mit Epoxypulver beschichtet in den Farben mattweiß oder grau metallisch.

**E**\_Estantes de vidrio templado transparente o de acero de alma llena o perforado, pintados con polvos epoxi blanco mate o gris metalizado.

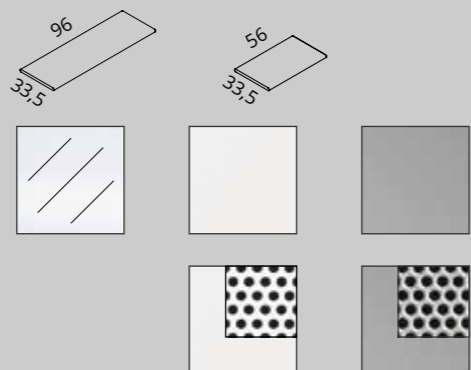

**I**\_Ripiani/espositori inclinati in acciaio microforato verniciato con polveri epossidiche colore bianco opaco o grigio metallizzato.

**EN**\_Sloped shelves/display units in epoxy powder-coated micro-perforated steel, matt white or metal gray.

**F**\_Présentoirs inclinés en acier micro-perforé peint en époxy, blanc mat ou gris métallisé.

**D**\_Schrägausstellungstablare/-regalfächer aus mit Epoxypulver beschichtetem Stahl, mattweiß oder grau metallisch.

**E**\_Estantes expositores inclinados en acero pintado con polvo epoxi, blanco mate o gris metalizado.

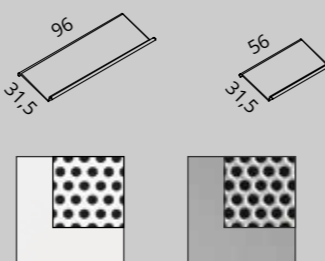

**I**\_Chiusure laterali in acciaio pieno verniciato con polveri epossidiche colore bianco opaco o grigio metallizzato.

**EN**\_Side closures in epoxy powder-coated solid steel, mat white or metal gray.

**F**\_Fermetures latérales en acier plein peint époxy blanc mat ou gris métallisé.

**D**\_Seitenteile aus mit Epoxypulver beschichtetem Stahl in den Farben mattweiß oder grau metallisch.

**E**\_Cierres laterales de acero compacto pintado con polvo epoxi color blanco mate o gris metalizado.

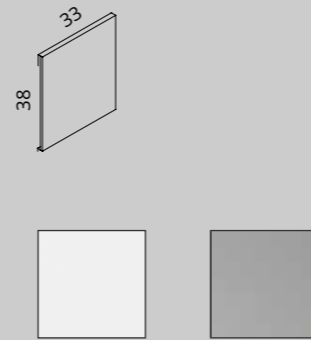

**I**\_Chiusure scorrevoli disponibili in acciaio verniciato con polveri epossidiche, in MDF placcato alluminio impiallacciato legno oppure in vetro satinato, trasparente o trasparente serigrafato. Guide in acciaio verniciato con polveri epossidiche.

**EN**\_The sliding closings come in epoxy powder-coated steel, in MDF (aluminum plated wood veneered), satin glass, glass, transparent glass and screen-printed transparent glass. Guides are available in epoxy powder-coated steel.

**F**\_Les fermetures coulissantes existent en acier peint avec des poudres époxy, en MDF plaqué aluminium avec placage bois ou en verre satiné, transparent ou sérigraphié transparent. Glissières en acier peint avec des poudres époxy.

**D**\_Schiebetüren sind aus epoxidstaublackiertem Stahl, aus MDF mit Aluminiumüberzug, aus holzbeschichtetem MDF oder aus mattiertem Glas (durchsichtig mit oder ohne Siebdruck) erhältlich. Schienen aus epoxidstaublackiertem Stahl.

**E**\_Puertas correderas de acero pintado con polvos epoxi, MDF revestido de aluminio, enchapado de madera o vidrio satinado, transparente o transparente serigrafado. Guías de acero pintado con polvos epoxi.

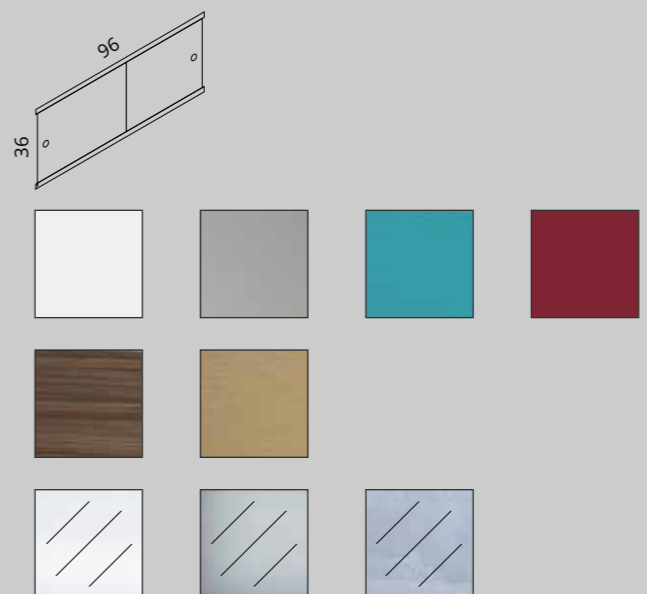

## SOCRATE Wall - Dimensions in cm

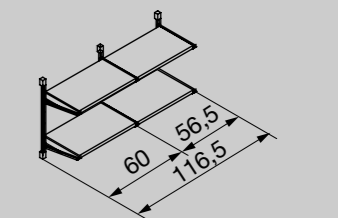
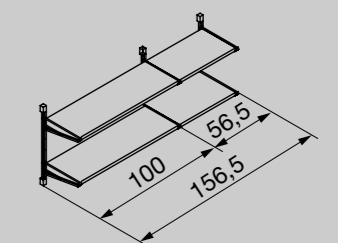
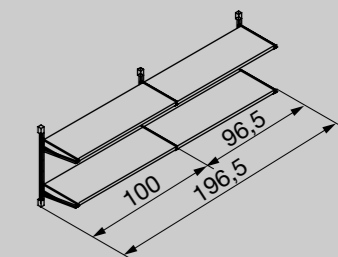
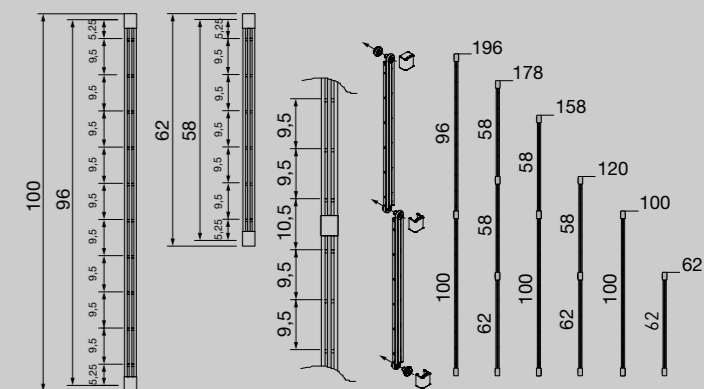

# BIG design Marc Sadler

**I**deata quasi come un componente architettonico, Big è una libreria in metallo caratterizzata da robusti montanti in alluminio estruso con sezione a "T" e da ripiani in lamiera con bordo frontale decisamente importante, visivamente assimilabili a ripiani in muratura. Accentua questo aspetto la finitura bianco opaco, molto simile ad una muratura rasata a gesso e imbiancata. Le sue forme decise e ben delineate la rendono un "oggetto polifunzionale", in grado di caratterizzare indifferentemente ambienti moderni, hi-tech, classici o storici.

**EN** Conceived almost as an architectural component, Big is a metal bookcase made of sturdy extruded aluminum uprights forming a "T" section and shelves in metal sheet, presenting a visually prominent front edge that gives the appearance of masonry shelves. The matt white finish accentuates this impression as it is highly reminiscent of brickwork stripped back to plaster and whitewashed. The pronounced and well-delineated shapes make this a multifunctional object that can fit equally well into a modern, hi-tech, classic or historical environment.

**F** Big est une bibliothèque en métal, conçue presque comme un élément architectural. Elle se distingue par ses montants robustes en aluminium extrudé avec profil en T et des étagères en tôle avec un rebord frontal très marqué, donnant l'idée d'étagères en maçonnerie. Cet aspect est renforcé par le finissage en blanc opaque, ressemblant beaucoup à une maçonnerie plâtrée et blanchie à la chaux. Ses formes bien définies en font un "objet polyvalent", capable de s'intégrer indifféremment dans des intérieurs modernes, hi-tech, classiques ou historiques.

**D** Einem architektonischen Bauelement nachempfunden, ist Big ein Metallregal mit starken T-Querschnitt-Ständern aus stranggepresstem Aluminium und Regalböden aus Blech mit einer besonders betonten Vorderkante, deren Aussehen an Mauerwerkablagen erinnert. Dieses Aussehen wird weiter von der matt-weißen Oberflächenbehandlung hervorgehoben, die einer angemalten Gipswand stark ähnelt. Die entschlossenen, klar definierten Linien machen aus Big ein "Mehrfunktionen-Objekt", das genauso gut zu modernen, Hi-Tech-Räumen wie zu klassischen Räumen mit geschichtlichem Flair passt.

**E** Concebida como si fuese un componente arquitectónico, Big es una librería de metal que se caracteriza por sus sólidos montantes de aluminio de extrusión con sección en "T" y por los estantes de metal con un característico borde anterior, muy parecidos a los estantes de mampostería. Acentúa este aspecto el acabado blanco opaco. Gracias a su diseño esencial y definido es un "objeto multifuncional" que logra caracterizar tanto los ambientes modernos y hi-tech como los clásicos.



Compasso d'Oro



















## BIG - Dimensions in cm

**I\_Montanti** in alluminio verniciato con polveri epossidiche colore bianco opaco o grigio argento.

**EN\_Uprights** in epoxy powder-coated mat white or silver grey aluminum.

**F\_Montants** en aluminium peint en époxy blanc mat ou gris argenté.

**D\_Seitenteil** aus mit Epoxypulver beschichtetem Aluminium, mattweiß oder silbergrau.

**E\_Laterales** de aluminio pintado con polvos epoxi, color blanco mate o gris plata.

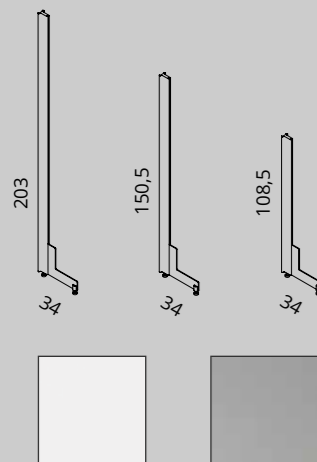

**I\_Ripiani** in acciaio verniciato con polveri epossidiche colore bianco opaco o grigio argento.

**EN\_Shelves** in epoxy powder-coated steel, mat white or silver grey.

**F\_Tablettes** en acier peint en époxy, blanc mat ou gris argenté.

**D\_Regalböden** aus mit Epoxypulver beschichtetem Stahl, mattweiß oder silbergrau.

**E\_Estantes** de acero pintado con polvos epoxi color blanco mate o gris plata.

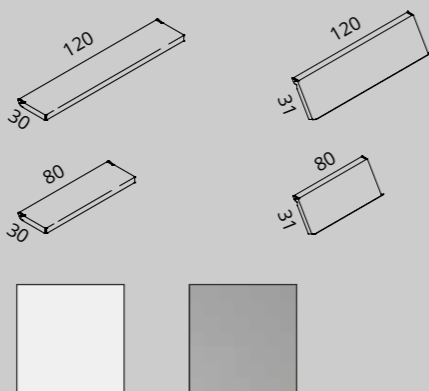

**I\_Traverse** in acciaio verniciato con polveri epossidiche colore bianco opaco o grigio argento.

**EN\_Crossbars** in epoxy powder-coated steel, mat white or silver grey.

**F\_Traverses** en acier peint en époxy, blanc mat ou gris argenté.

**D\_Traverse** aus mit Epoxypulver beschichtetem Stahl, mattweiß oder silbergrau.

**E\_Traversales** de acero pintado con polvos epoxi color blanco mate o gris plata.

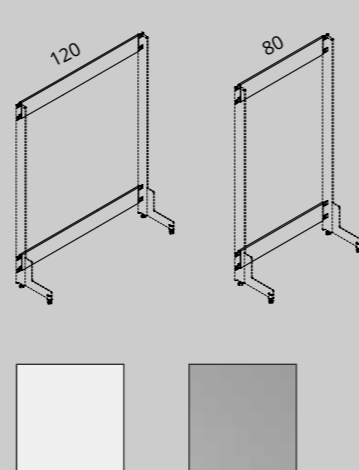

**I\_Montanti** in alluminio verniciato con polveri epossidiche colore bianco opaco o grigio argento.

**EN\_Uprights** in epoxy powder-coated mat white or silver grey aluminum.

**F\_Montants** en aluminium peint en époxy blanc mat ou gris argenté.

**D\_Seitenteil** aus mit Epoxypulver beschichtetem Aluminium, mattweiß oder silbergrau.

**E\_Laterales** de aluminio pintado con polvo epoxi, color blanco mate o gris plata.

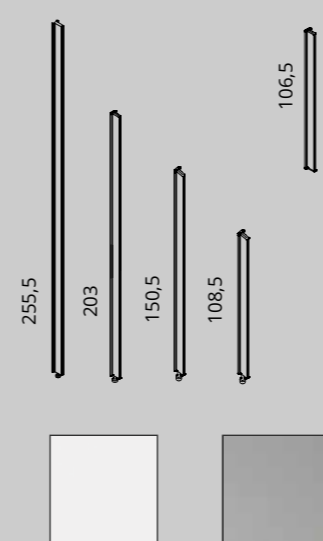

**I\_Ripiani** in acciaio verniciato con polveri epossidiche colore bianco opaco o grigio argento.

**EN\_Shelves** in epoxy powder-coated steel, mat white or silver grey.

**F\_Tablettes** en acier peint en époxy, blanc mat ou gris argenté.

**D\_Regalböden** aus mit Epoxypulver beschichtetem Stahl, mattweiß oder silbergrau.

**E\_Estantes** de acero pintado con polvos epoxi color blanco mate o gris plata.

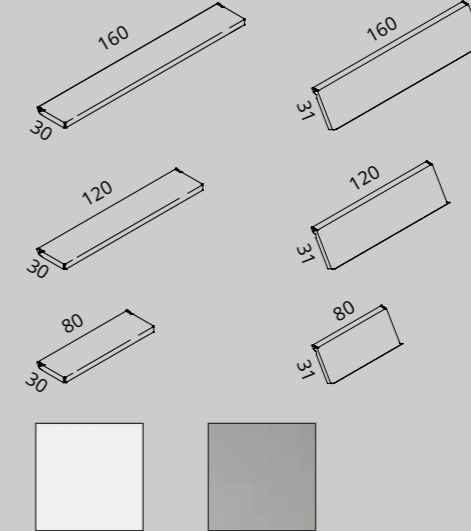

## BIG Wall - Dimensions in cm

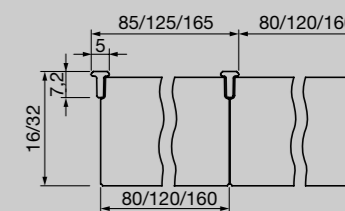
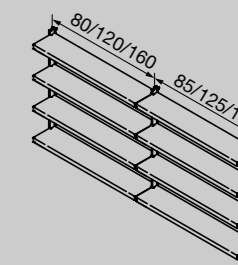



# PEGASO

Angelotti & Cardile

**I**\_Tavolo con struttura in alluminio lucido o verniciato, composta da quattro gambe in fusione monoblocco, dotate di piedini regolabili, e da una traversa in tubolare. Piano in vetro temperato e molato trasparente o satinato, spessore 12 mm. L'aggancio dei piani alla struttura è realizzato tramite speciali dischi in acciaio inossidabile incollati al piano.

**EN**\_Table with polished or powder-coated aluminum structure formed by four legs in monobloc casting, supplied with adjustable feet, and a tubular crosspiece. Top in tempered and ground glass, transparent or mat, 12 mm thick. The tops are connected to the structure through special discs in stainless steel glued to the top.

**F**\_Table avec corps en aluminium poli ou peint en époxy formée de quatre pieds en fusion monobloc, dotés de pieds réglables et d'une entretoise en tubulaire. Dessus en verre trempé et meulé, transparent ou mat, 12 mm d'épaisseur. Le dessus est accroché à la structure au moyen de disques spéciaux en acier inoxydable collés à la surface.

**D**\_Tisch mit Gestell aus poliertem oder pulverbeschichtetem Aluminium, bestehend aus vier Beinen aus einem Gussstück, mit höhenverstellbaren Füßchen und einem Querstab aus Rohreisen. Tischfläche aus gehärtetem und transparent oder matt geschliffenem Glas, Dicke 12 mm. Die Verbindung der Platten mit dem Gestell ist aus speziellen rostfreien Stahlscheiben, die auf die Platten geklebt sind.

**E**\_Mesa con estructura de aluminio pulido o pintado con polvos epoxi, formada por cuatro patas de fusión monobloque, dotadas de apoyos regulables y un travesaño de tubo. Superficie de vidrio templado y pulido transparente o satinado, espesor 12 mm. Las superficies se enganchan a la estructura mediante discos especiales de acero inoxidable que van pegados a la superficie.

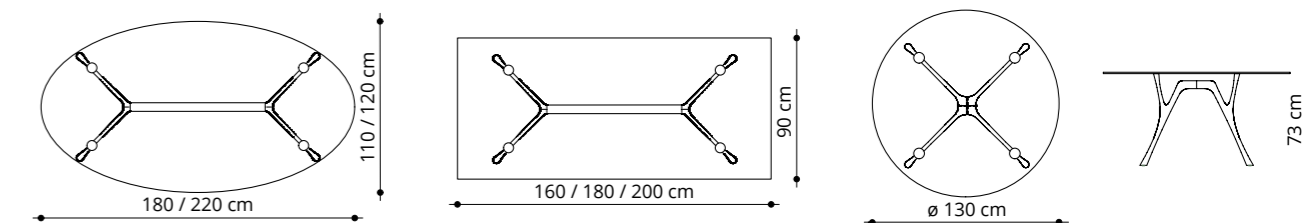









# PEGASO Infinito

Angelotti & Cardile

**I**\_Tavolo componibile in lunghezza con struttura in alluminio e piano in vetro temperato e molato trasparente. L'aggancio dei piani alla struttura è realizzato tramite speciali dischi in acciaio inossidabile incollati al piano.

**EN**\_Modular table in length with aluminum structure and top in tempered, ground glass, transparent. The top is linked to the structure through special disks in stainless steel glued to the top.

**F**\_Table modulaire avec structure en aluminium et dessus en verre trempé et biseauté transparent. L'accrochement des plans à la structure est réalisé au moyen de disques spéciaux en inox collés au plan.

**D**\_Modulares Tischsystem mit Untergestell aus Aluminium und Tischplatte aus gehärtetem und geschliffenem Glas, transparent. Die Befestigung der Tischplatte am Gestell erfolgt mit speziellen Scheiben aus Edelstahl, die an die Fläche geklebt werden.

**E**\_Mesa con estructura de aluminio y superficie de vidrio templado y pulido transparente. El enganche de las superficies a la estructura se realiza mediante discos especiales de acero inoxidable que están pegados a la superficie.





# PEGASO Cemento/Solid/Metal

Angelotti & Cardile

**I**\_Design rigoroso per il tavolo Pegaso, studiato per raggiungere anche dimensioni importanti e proposto con piano in composito estremamente leggero con struttura a “sandwich” costituito da un’anima in legno listellare, racchiuso tra due lastre di alluminio rivestite nella parte superiore e sui bordi perimetrali con un foglio di resina acrilica bianca spazzolata oppure rivestite in cemento o in resina metallica finitura bronzo fuso o ghisa, in cui il carattere artigianale della lavorazione rende ogni pezzo unico ed esclusivo. Alla semplicità e pulizia formale del piano sia nella versione cemento che resina, si contrappongono le forme sinuose della struttura, realizzata in alluminio lucido o verniciato con polveri epossidiche.

**EN**\_Clean design for Pegaso table, designed to reach large dimensions and proposed with table top made in a very lightweight composite with a layered structure made up of a wooden strips core, enclosed between two sheets of aluminum on the top and around the perimeter lined with a white, brushed acrylic sheet or covered with cement or in metallic resin in a molten bronze or cast iron finish. The handcrafted quality of the workmanship makes every piece unique and exclusive. The sleek formal simplicity of the table top in the cement and resin versions is complemented by the sinuous shape of the structure, built in polished or epoxy powder-coated aluminum.

**F**\_Design rigoureux pour la table Pegaso, conçue pour atteindre des grandes dimensions et proposée avec plateau réalisé à partir d’un matériau composite extrêmement léger avec une structure en “sandwich”. Il est constitué d’une âme en contreplaqué latté et est renfermé entre deux plaques d’aluminium revêtues sur la partie supérieure et recouvertes d’une feuille de résine acrylique blanche brossée ou revêtues de béton ou de résine métallique avec finition en bronze fondu ou en fonte. Le caractère artisanal de l’ouvrage rend chaque pièce unique et exclusive. La simplicité et la netteté des formes du plateau, aussi bien dans la version béton que résine, sont en contraste avec les formes sinueuses de la structure, réalisée en aluminium poli ou peint en époxy.

**D**\_Klares Design zeichnet das Tischmodell Pegaso aus, dessen Ausführung sich auch hervorragend für große Dimensionen eignet. Die Tischplatte besteht aus einem extrem leichten Verbundmaterial mit einer “Sandwich-Struktur”, die sich aus einem Sperrholzkern zwischen zwei Aluminiumplatten zusammensetzt. Die Tischoberfläche und die Kanten sind mit einer Schicht weißem gebürstetem Acrylharz verkleidet oder mit Zement, Bronzeguss-Optik oder Gusseisen-Optik beschichtet. Jede Tischplatte ist handgefertigt und daher ebenso einzigartig wie exklusiv. Die Einfachheit und formale Reinheit der Tischplattenausführung in Zement bzw. Acrylharz bildet einen interessanten Kontrast zur geschwungenen Form des Untergestells aus poliertem oder pulverbeschichtetem Aluminium.

**E**\_Un diseño riguroso para la mesa Pegaso, estudiado para conseguir grandes dimensiones y propuesto con plano en composito extremadamente ligero, con estructura a “sandwich” que consiste en un núcleo hecho de láminas de madera encerrado entre dos hojas de aluminio pintado por la parte superior y en los bordes con una lámina de resina acrílica blanca cepillada o pintado en hormigón o en resina metálica con acabado de bronce fundido o fundición gris donde la artesanía del trabajo hace que cada pieza sea única y exclusiva. La simplicidad y las líneas limpias del plan tanto en la versión de cemento que de resina, contrasta con las formas sinuosas de la estructura, fabricado en aluminio pulido o pintado con polvos epoxi.

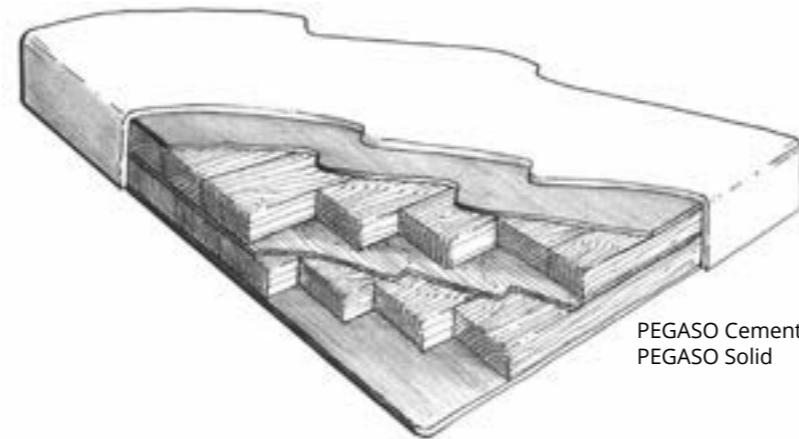

PEGASO Cemento  
PEGASO Solid

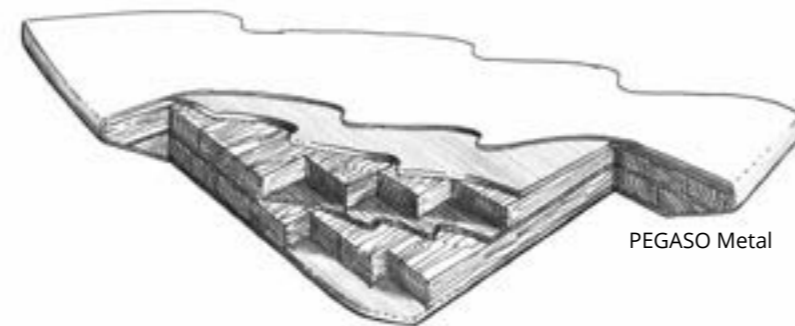

PEGASO Metal



# PEGASO Cemento

Angelotti & Cardile

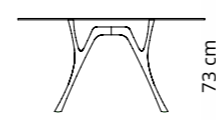
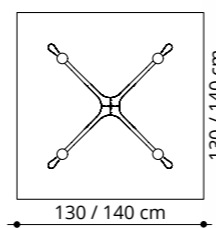
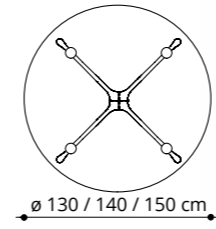
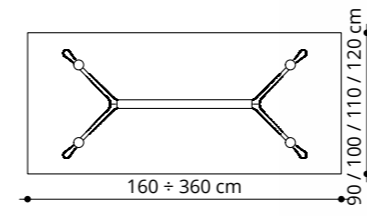
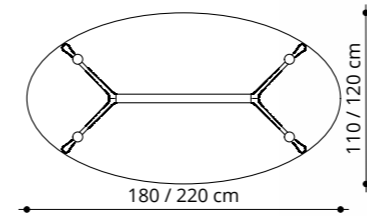



# PEGASO Solid

Angelotti & Cardile

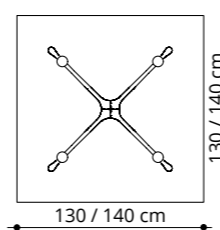
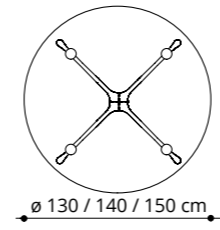
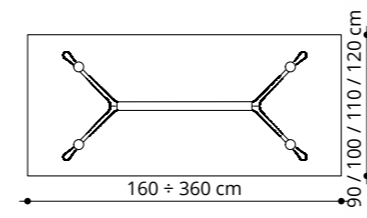
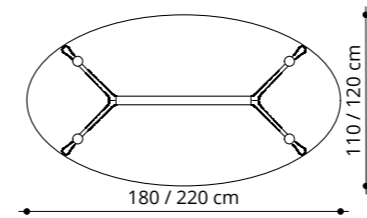





# PEGASO Metal

Angelotti & Cardile

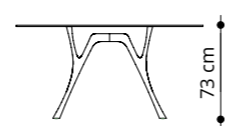
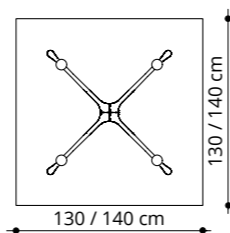
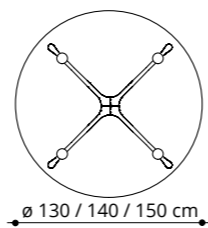
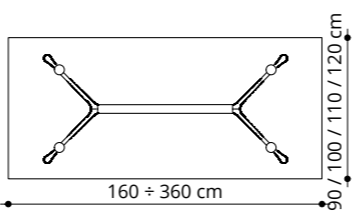
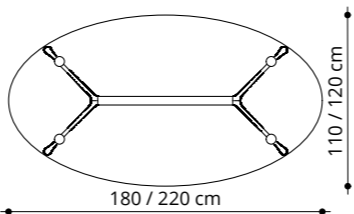
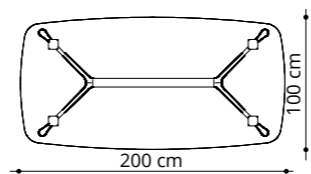



MOLTEN BRONZE FINISH



CAST IRON FINISH

# NEWTON

Caimi Lab

**I**\_Tavolo con struttura in acciaio verniciato con polveri epossidiche e piano in melaminico con bordi arrotondati. Piedini regolabili in altezza.

**EN**\_Table with an epoxy powder-coated steel frame, with melamine top with rounded edges. Height-adjustable feet.

**F**\_Une table avec une structure en acier peint avec poudres époxy et une surface en mélamine aux bords arrondis. Des pieds à hauteur réglable.

**D**\_Tisch mit Struktur aus epoxidstaublackiertem Stahl und Melamin-Tischplatte mit abgerundeten Kanten. Tischfuß höhenverstellbar.

**E**\_Mesa con estructura de acero pintado con polvos epoxi y superficie de apoyo en melamina con bordes redondeados. Pies de altura ajustable.

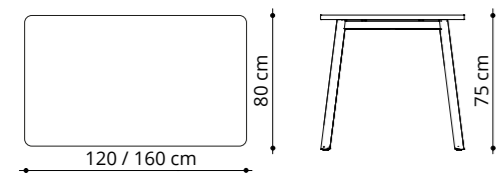



# CICERONE

Lorenzo Stano

**I**\_Tavolini con piano disponibile in laminato stratificato HPL oppure in vetro spessore 12 mm, temperato e molato. Colonna in acciaio verniciato con polveri epossidiche. Basi in acciaio verniciato con polveri epossidiche e rivestite in acciaio inossidabile lucido. Le basi sono dotate di predisposizione per il fissaggio a terra. I piani in vetro sono applicati alla struttura mediante speciali dischi in acciaio inossidabile. La struttura di sostegno del piano dei tavolini Cicerone è dotata di ganci portaborse ed è realizzata in fusione di alluminio verniciato con polveri epossidiche.

**EN**\_Coffee tables with tops in multilayer HPL laminate or in 12 mm tempered, polished glass. The column comes in epoxy powder-coated steel. Bases are in epoxy powder-coated steel and plated in polished stainless steel. Bases can also be anchored to the floor. Glass tops are applied to the structure using special stainless steel disc fasteners. The support structure of the Cicerone coffee tables top is equipped with bag hooks and is made of epoxy powder coated aluminum casting.

**F**\_Tables avec plan disponible en stratifié HPL ou en verre épaisseur 12 mm, trempé et biseauté. Colonne en acier peint en époxy. Bases en acier peint en époxy et revêtues en acier inox brillant. Les bases sont prédisposées pour être fixées au sol. Les plans en verre sont appliqués à la structure avec des disques spéciaux en acier inox. La structure qui soutient le plan des tables basses Cicerone est munie de crochets pour les sacs à main, elle est réalisée en fonte d'aluminium peint en époxy.

**D**\_Tischchen mit Platte aus mehrschichtigem HPL-Laminat oder aus gehärtetem und geschliffenem 12 mm-Glas. Säule aus pulverbeschichtetem Stahl. Bodenplatte pulverbeschichtet und mit glänzender Edelstahlbeschichtung. Die Bodenplatte verfügt über eine Vorrichtung für die Bodenbefestigung. Die Glastischplatten können dank besonderer Edelstahlscheiben am Untergestell angebracht werden. Das Untergestell der Cicerone-Tischchen verfügt über Haken zum Aufhängen von Taschen und besteht aus Aluminiumguss, pulverbeschichtet.

**E**\_Mesitas con plano disponible en laminado HPL o en vidrio templado de 12 mm. de grosor y molturado. Columna de acero pintado con polvos epoxi. Bases de acero recubiertas con polvos epoxi y revestidas en acero inox brillante. Las bases vienen equipadas para anclarse al suelo. Las repisas de vidrio se aplican a la estructura a través de especiales discos de acero inox. La estructura de apoyo de la repisa de las mesitas Cicerone va equipada con colgadores para bolsos y esta realizada en aluminio fundido pintado con polvo epoxi.

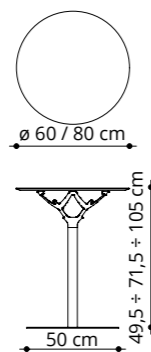

# JOLLY

CaimiLab

**I**\_Tavolini con piano disponibile in laminato stratificato HPL oppure in vetro spessore 12 mm, temperato e molato. Colonna in acciaio cromato o verniciato con polveri epossidiche. Basi in acciaio verniciato con polveri epossidiche o rivestite in acciaio inossidabile lucido. Le basi sono dotate di predisposizione per il fissaggio a terra. I piani in vetro sono applicati alla struttura mediante speciali dischi in acciaio inossidabile.

**EN**\_Coffee tables with tops in multilayer HPL laminate or in 12 mm tempered, polished glass. The column comes in chrome-plated or epoxy powder-coated steel. Bases are in epoxy powder-coated steel, or plated in polished stainless steel. Bases can also be anchored to the floor. Glass tops are applied to the structure using special stainless steel disc fasteners.

**F**\_Tables avec plan disponible en stratifié HPL ou en verre épaisseur 12 mm, trempé et biseauté. Colonne en acier chromé ou peint en époxy. Bases en acier peint en époxy ou revêtues en acier inox brillant. Les bases sont prédisposées pour être fixées au sol. Les plans en verre sont appliqués à la structure avec des disques spéciaux en acier inox.

**D**\_Tischchen mit Platte aus mehrschichtigem HPL-Laminat oder aus gehärtetem und geschliffenem 12 mm-Glas. Säule aus verchromtem oder pulverbeschichtetem Stahl. Bodenplatte pulverbeschichtet oder mit glänzender Edelstahlbeschichtung. Die Bodenplatte verfügt über eine Vorrichtung für die Bodenbefestigung. Die Glastischplatten können dank besonderer Edelstahlscheiben am Untergestell angebracht werden.

**E**\_Mesitas con plano disponible en laminado HPL o en vidrio templado de 12 mm. de grosor y molido. Columna de acero cromado o pintado con polvos epoxi. Bases de acero recubiertas con polvos epoxi o revestidas en acero inox brillante. Las bases vienen equipadas para anclarse al suelo. Las repisas de vidrio se aplican a la estructura a través de especiales discos de acero inox.

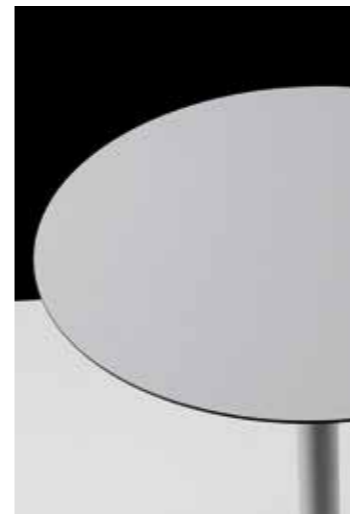
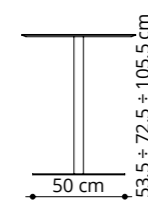
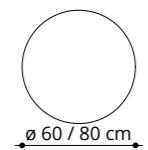
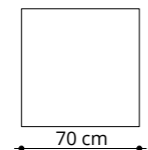

# KALEIDOS

Michele De Lucchi, Sezgin Aksu

**I**\_Kaleidos ha una linea pura, arricchita dalla particolarissima finitura superficiale della scocca che le dona effetti ottici tridimensionali e riflessi sorprendenti; la particolare texture conferisce inoltre un'inedita piacevolezza al tatto. Per la scocca, costituita da un unico pezzo, è stato scelto un poliammide riciclabile. Le strutture portanti in acciaio sono disponibili in diverse varianti.

**EN**\_Kaleidos has pure lines, enriched by the unique surface of the seat, giving three-dimensional optical effects and wonderful reflections; in addition, the particular texture is unusually pleasing to the touch. The shell is made of a single piece in recyclable polyamide. The steel support frames are available in different models.

**F**\_Kaleidos présente une ligne propre, enrichie par une finition de surface unique de la coque qui lui confère des effets optiques tridimensionnels et des reflets surprenants. La texture ainsi définie permet de réaliser une surface unique au toucher. La coque, en une seule pièce, est réalisée en polyamide recyclable. Les structures portantes en acier sont disponibles dans plusieurs variantes.

**D**\_Kaleidos zeichnet sich durch klare Linien aus, die durch die besondere Oberflächenverarbeitung der Sitzschale betont werden, welche für dreidimensionale Effekte und schöne Reflektionen, sowie dafür sorgt, dass das Material sich sehr angenehm anfühlt. Die Sitzschale besteht aus einem einzigen Stück recycelbaren Polyamid. Das Stuhlgestell aus Stahl existiert in verschiedenen Ausführungen.

**E**\_Kaleidos tiene una línea pura, enriquecida por el especialísimo acabado superficial del bastidor que le proporciona efectos ópticos tridimensionales y reflejos sorprendentes; además, su particular textura ofrece un inédito placer al tacto. Para el bastidor, constituido por una pieza única, se ha elegido una poliamida reciclable. Las estructuras portantes de acero están disponibles en diferentes variantes.

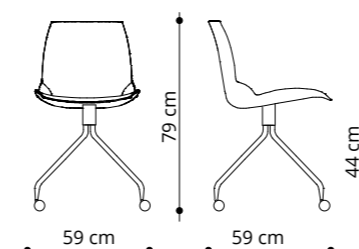
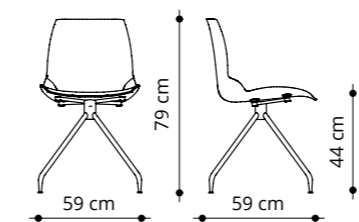
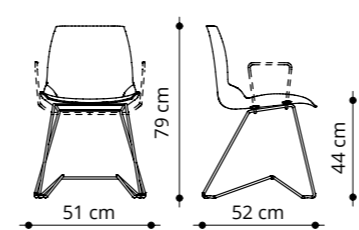
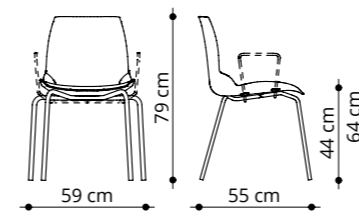







# KALEIDOS Fabric

Michele De Lucchi, Sezgin Aksu

**I**\_Sedia Kaleidos con scocca in poliammide riciclabile con imbottitura in poliuretano e rivestimento in tessuto Trevira CS®. Le strutture portanti in acciaio sono disponibili in diverse varianti.

**EN**\_Kaleidos chair with recyclable polyamide seat with polyurethane padding, upholstered in TreviraCS® fabric. The steel support frames are available in different models.

**F**\_Siège Kaleidos avec coque en polyamide recyclable avec rembourrage en polyuréthane et revêtement en tissu Trevira CS®. Les structures portantes en acier sont disponibles dans plusieurs variantes.

**D**\_Kaleidos Stuhl mit Sitzschale aus recycelbaren Polyamid, Polyurethan-Polsterung mit Bezug aus Trevira CS®. Das Stuhlgestell aus Stahl existiert in verschiedenen Ausführungen.

**E**\_Silla Kaleidos con bastidor en poliamida reciclable con acolchado de poliuretano, tapizada en tejido Trevira CS®. Las estructuras portantes de acero están disponibles en diferentes variantes.

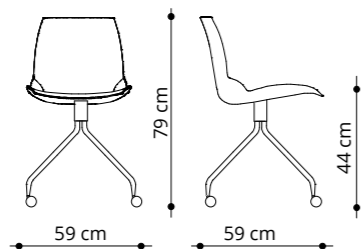
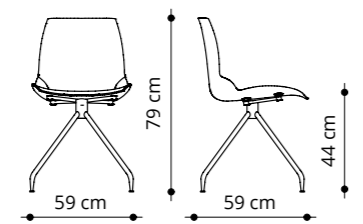
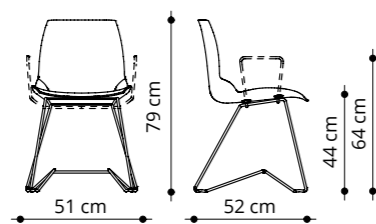
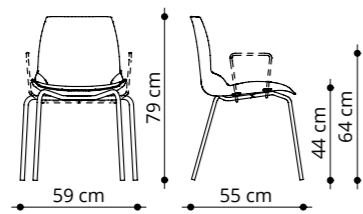

# KALEIDOS Stool

Michele De Lucchi, Sezgin Aksu

**I**Lo sgabello Kaleidos ha una linea pura, arricchita dalla particolarissima finitura superficiale della scocca che le dona effetti ottici tridimensionali e riflessi sorprendenti; la particolare texture conferisce inoltre un'inedita piacevolezza al tatto. Per la scocca, costituita da un unico pezzo, è stato scelto un poliammide riciclabile. Strutture realizzate in tondino di acciaio cromato.

**EN**The Kaleidos stool has pure lines, enriched by the very special finishing of the seat surface, which offers three-dimensional optical effects and pleasing reflections; the unusual texture confers a totally new and pleasant tactile effect. A recyclable polyamide was selected for the seat, consisting of just one piece. Structural frames in chrome plated steel rod.

**F**Le tabouret Kaleidos a une ligne pure, enrichie d'une finition superficielle de la coque très particulière qui lui donne des effets optiques tridimensionnels et des reflets surprenants; la texture particulière apporte aussi une touche agréable inédite. La coque, constituée d'une seule pièce, est composée d'un polyamide recyclable. Structures réalisées en rond d'acier chromé.

**D**Der Hocker Kaleidos verfügt über eine klare Linie, aufgewertet durch die spezielle Oberfläche der Sitzschale, die ihm dreidimensionale Optikeffekte und überraschende Reflexe schenkt; die besondere Textur verleiht den Stühlen außerdem eine Beschaffenheit, die sich unvergleichlich angenehm anfühlt. Für den Sitz, der aus einem einzigen Stück angefertigt ist, wurde ein zu 100% recyclebares Polyamid gewählt. Das Untergestell besteht aus verchromtem Rundstahl.

**E**El taburete Kaleidos tiene una línea pura, enriquecida por el especialísimo acabado superficial del armazón que le proporciona efectos ópticos tridimensionales y reflejos sorprendentes; la especial textura proporciona un inédito placer al tacto. Para el armazón, constituido por una pieza única, se ha elegido una poliamida reciclable. La estructura consta de una varilla de acero cromado.

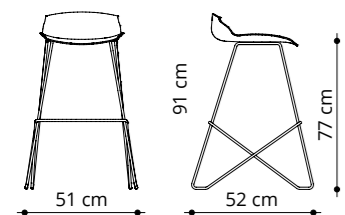



132 - KALEIDOS Michele De Lucchi, Sezgin Aksu



KALEIDOS Stool Michele De Lucchi, Sezgin Aksu - 133



# KALEIDOS Beam

Michele De Lucchi, Sezgin Aksu

**I**\_Kaleidos ha una linea pura, arricchita dalla particolarissima finitura superficiale della scocca che le dona effetti ottici tridimensionali e riflessi sorprendenti; la particolare texture conferisce inoltre un'inedita piacevolezza al tatto. Per la scocca, costituita da un unico pezzo, è stato scelto un poliammide riciclabile. Il tavolino con bordo di contenimento è in fusione di alluminio verniciato con polveri epossidiche. Travi e gambe sono in acciaio verniciato con polveri epossidiche.

**EN**\_Kaleidos has pure lines, enriched by the unique surface of the seat, giving three-dimensional optical effects and wonderful reflections; in addition, the distinct texture is unusually pleasing to the touch. The shell is made of a single piece in recyclable polyamide. The small table comes with a retaining border, and is in powder-coated cast aluminum. Beams and legs are made in powder-coated steel.

**F**\_Kaleidos présente une ligne propre, enrichie par une finition de surface unique de la coque qui lui confère des effets optiques tridimensionnels et des reflets surprenants. La texture ainsi définie permet de réaliser une surface unique au toucher. La coque, en une seule pièce, est réalisée en polyamide recyclable. La petite table avec le bord de finition est réalisée en fusion d'aluminium peint en époxy. Poutres et piétements sont en acier peint en époxy.

**D**\_Kaleidos zeichnet sich durch klare Linien aus, die durch die besondere Oberflächenverarbeitung der Sitzschale betont werden, welche für dreidimensionale Effekte und schöne Reflektionen, sowie dafür sorgt, dass das Material sich sehr angenehm anfühlt. Die Sitzschale besteht aus einem einzigen Stück recycelbaren Polyamid. Der Tisch besteht aus pulverbeschichtetem Aluminiumguss, die Traversen und Standfüße aus pulverbeschichtetem Stahl.

**E**\_Kaleidos tiene una línea pura, enriquecida por el especialísimo acabado superficial del bastidor que le proporciona efectos ópticos tridimensionales y reflejos sorprendentes; además, su particular textura proporciona un inédito placer al tacto. Para el bastidor, constituido por una pieza única, se ha elegido una poliamida reciclable. La mesita, con borde de contención es de fundición de aluminio pintado con polvos epoxi. Las vigas y patas son de acero pintado con polvos epoxi.

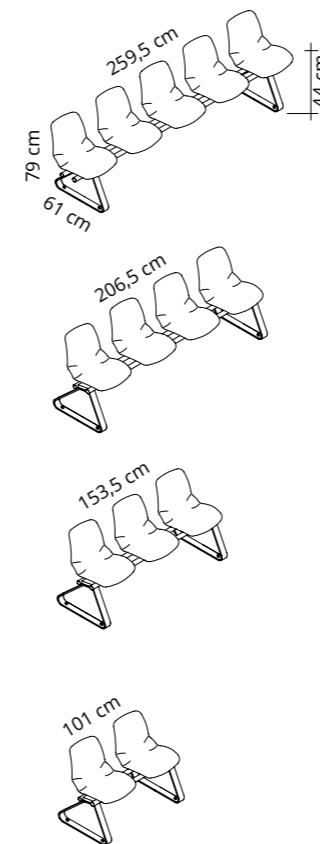
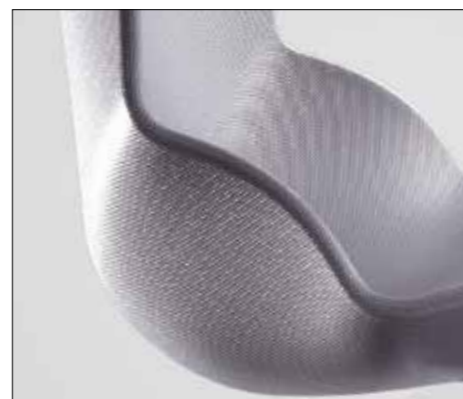



# ULISSE

Caimi Lab

**I**\_Sistemi di sedute modulari con scocche e tavolini realizzati in lamiera di acciaio forata verniciata con polveri epossidiche. I supporti, le travi e le particolari basi coniche sono in acciaio verniciato con polveri epossidiche. Bracciolo in alluminio verniciato con polveri epossidiche.

**EN**\_Modular beam seating system with seats and side tables in epoxy powder-coated perforated steel sheet. The supports, the beams and the conical bases are made from epoxy powder-coated steel. Powder-coated aluminum armrest.

**F**\_Système modulaire de sièges sur poutre avec coquess et tables réalisées en tôle d'acier perforée peinte en epoxy. Les supports, les poutres et les bases coniques très particulières sont en acier peint époxy. Accoudoirs en aluminium peint en époxy.

**D**\_Modulare Traversensitzbank mit Untergestell und Tischen aus lackiertem gelochtem Stahlblech. Halterungen, Träger und die speziellen kegelförmigen Beine bestehen aus epoxypulverlackiertem Stahl. Armlehnen aus pulverbeschichtetem Aluminium.

**E**\_Sistema de asientos modulares con armazones y mesas de chapa de acero perforada recubierta con polvo epoxi. Los soportes, las vigas y las peculiares bases cónicas son de acero pintado con polvo epoxi. Apoyabrazo en aluminio pintado con polvo epoxi.

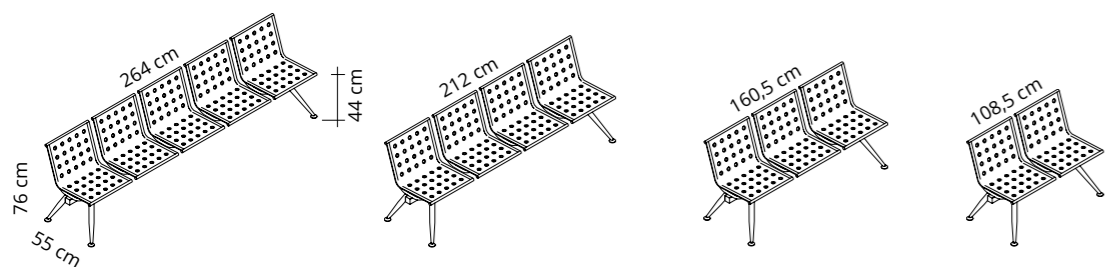







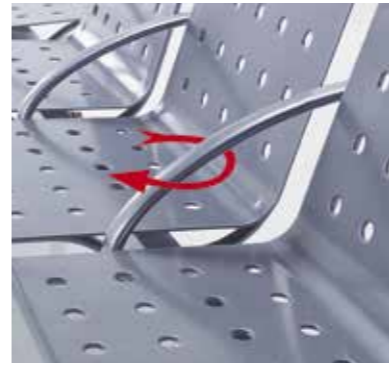

# ULISSE Inox

Caimi Lab

**I** Sistema di sedute modulari con scocche e tavolini realizzati in lamiera di acciaio forato inossidabile AISI 304 con finitura satinata. I supporti, le travi e le particolari basi coniche sono in acciaio verniciato con polveri epossidiche. Bracciolo in alluminio verniciato con polveri epossidiche.

**EN** Modular beam seating system with seats and side tables in AISI 304 stainless steel sheet with satin finish. The supports, the beams and the conical bases are made from epoxy powder-coated steel. Powder-coated aluminum armrest.

**F** Système modulaire de sièges sur poutre avec coques et tables réalisées en tôle d'acier perforée inoxydable AISI 304 avec finition satinée. Les supports, les poutres et les bases coniques très particulières sont en acier peint époxy. Accoudoirs en aluminium peint en époxy.

**D** Modulare Traversensitzbank mit Untergestell und Tischen aus gelochtem rostfreiem Stahlblech AISI 304 mit satiniertes Oberfläche. Halterungen, Träger und die speziellen kegelförmigen Beine bestehen aus epoxypulverlackiertem Stahl. Armlehnen aus pulverbeschichtetem Aluminium.

**E** Sistema de asientos modulares con armazones y mesas de chapa de acero perforada inoxidable AISI 304 con acabado satinado. Los soportes, las vigas y las peculiares bases cónicas son de acero pintado con polvo epoxi. Apoyabrazo en aluminio pintado con polvo epoxi.

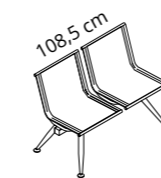
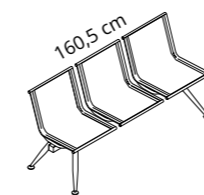
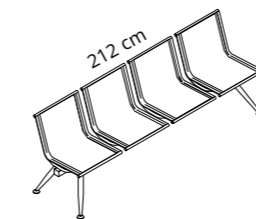
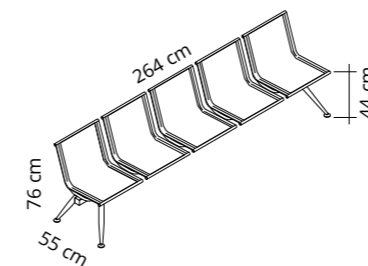



# DIVIDERS & PARTITIONS

**I** Serie di schermi divisori, sistemi di separazione e colonnine serventi, pensate per tutti quegli ambienti, pubblici e privati, in cui è necessario dividere, separare e organizzare lo spazio, i percorsi e la comunicazione. Prodotti dal design essenziale o connotati da un design unico e riconoscibile, capaci di adattarsi a qualsiasi tipo di ambiente.

**EN** A series of dividing screens, partition systems and stanchions, designed for any public or private space that needs to be divided, partitioned off or organized into delimited areas and pathways. The partitions and dividers can also be used to display signs and information. Products with an austere, unique and recognizable design that are capable of fitting into any type of environment.

**F** Série d'écrans de division, de systèmes de séparation et de poteaux de guidage, conçus pour tous les lieux, publics et privés, où il est nécessaire de diviser, séparer et organiser l'espace, les parcours et la communication. Des produits au design essentiel ou caractérisés par un design unique et reconnaissable, capables de s'adapter à tout type d'intérieur.

**D** Eine Reihe von Trennwänden, Trennsystemen und Funktionsständern, die für jene privaten oder öffentlichen Räume gedacht sind, in denen die Notwendigkeit besteht, den Raum, die Gänge und die Kommunikation zu trennen, aufzuteilen und zu organisieren. Diese minimalen, durch einzigartiges und erkennbares Design konnotierten Produkte sind in der Lage, sich jeder Art von Raum anzupassen.

**E** Serie de pantallas, sistemas y postes separadores concebidos para todos los ambientes, públicos y privados, en los que es necesario dividir, separar y organizar el espacio, los itinerarios y la comunicación. Productos con un diseño esencial, que se caracterizan por una estética única e identificable, se ajustan a todo tipo de ambientes.

# ARIANNA

Caimi Lab

**I**\_Arianna è un sistema modulare di schermi divisori flessibili. I pannelli sono fissati ai montanti tramite attacchi fissi o particolari attacchi magnetici che consentono l'aggancio/sgancio rapido del pannello.

**EN**\_Arianna is a modular system with flexible partitions. Panels are attached to the posts with either screws or special magnetic fasteners that make it easy to quickly install/remove the panel.

**F**\_Arianna est un système modulaire de cloisons flexibles. Les panneaux sont fixés aux poteaux par des attaches fixes ou des attaches magnétiques particulières qui permettent de les accrocher/décrocher rapidement.

**D**\_Arianna ist ein Baukastensystem für flexible Trennwände. Die Paneele werden mit festen oder magnetischen Befestigungen angebracht, sodass sie schnell ein- und ausgehängt werden können.

**E**\_Arianna es un sistema expansible de mamparas flexibles. Los paneles van fijados a los montantes a través de soportes fijos o magnéticos especiales que permiten acoplar y desacoplar rápidamente el panel.



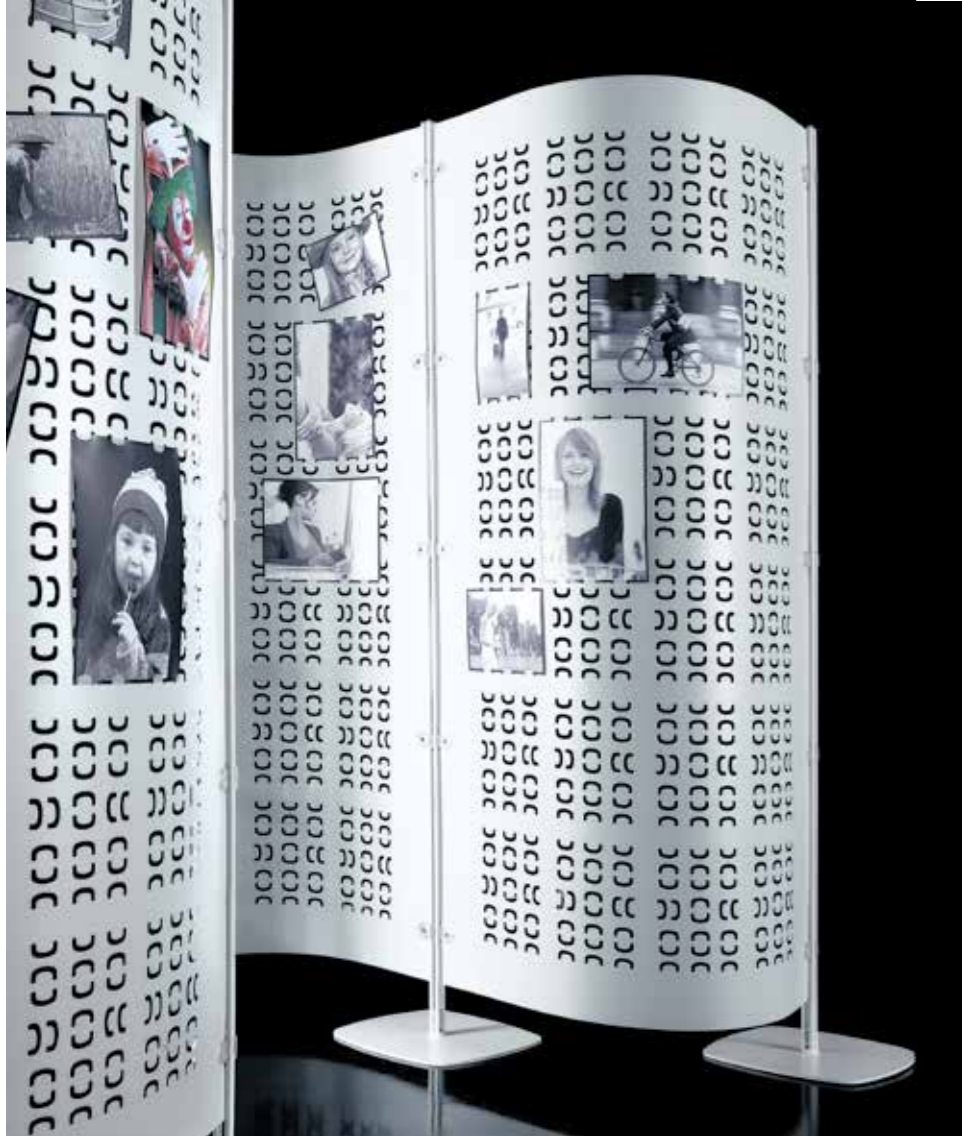

156 - **ARIANNA** Caimi Lab



157 - **ARIANNA** Granelli Caimi Lab / Frida Doveil



**ARIANNA** Granelli Caimi Lab / Frida Doveil - 157









FIXED CONNECTORS

MAGNETIC CONNECTORS

**I**\_Basi in acciaio e montanti in tondino d'acciaio verniciato con polveri epossidiche con tappo superiore in tecnopolimero traslucido. Disponibili nei colori bianco opaco o grigio argento.

**EN**\_Epoxy powder-coated steel bases and steel rod uprights with upper cap in translucent high-tech polymer. Available in mat white or silver grey.

**F**\_Bases en acier et poteaux en rond d'acier peint époxy avec protection supérieure en techno-polymère translucide. Disponibles en blanc mat ou gris argenté.

**D**\_Bodenplatte aus mit Epoxypulver beschichtetem Stahl und Standsäule aus mit Epoxypulver beschichtetem Rundstahl mit oberer Abdeckung aus transparentem Technopolymer. Erhältlich in mattweiß oder silbergrau.

**E**\_Bases de acero y montantes en redondo de acero pintado con polvos epoxi con tapón superior de tecnopolímero traslucido. Disponible en color blanco mate o gris plata.

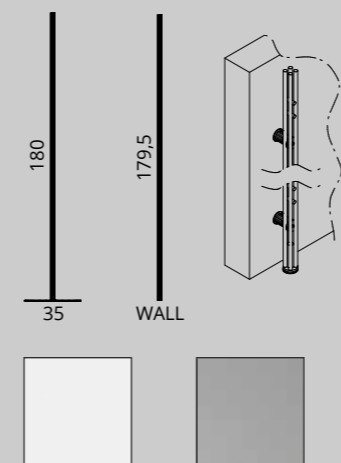

**I**\_Schermi divisori in tecnopolimero flessibile trasparente, bisatinato o trasparente serigrafato, oppure in PP.

**EN**\_Partition screens in transparent, double satin or screen-printed (transparent) finish flexible high-tech polymer or in PP.

**F**\_Cloisons en technopolymère souple transparent, satiné double faces ou transparent sérigraphié ou en PP.

**D**\_Trennwände aus flexiblem, durchsichtigem oder beidseitig satiniertem oder transparentem bedrucktem Technopolymer, oder aus PP.

**E**\_Paneles divisorios de tecnopolímero flexible transparente, bisatinado o transparente serigrafado o de PP.

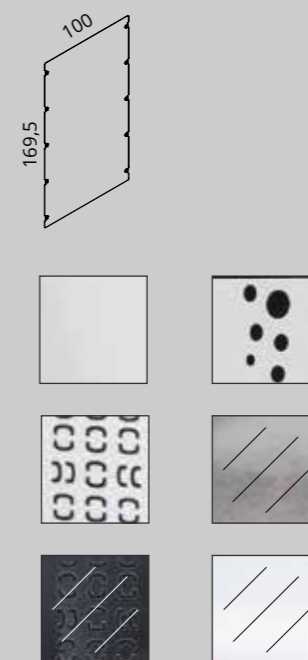

ARIANNA - Dimensions in cm

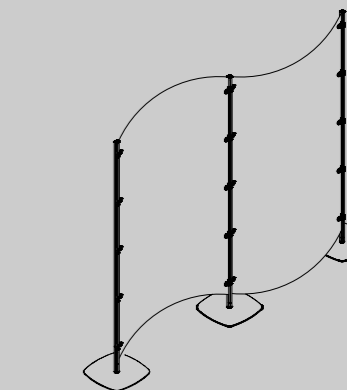
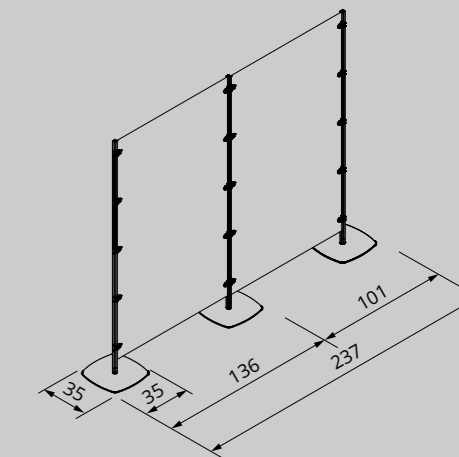

# ARCHIMEDE

Caimi Lab

**I**\_Sistema di schermi divisori componibili ed accessoriabili. Archimede è un sistema aperto costituito da elementi modulari che si assemblano in modo flessibile tra loro per generare diverse configurazioni in grado di soddisfare elegantemente esigenze estetiche e funzionali.

**EN**\_System of sectional partition screens that can be fitted with accessories. Archimede is an open system formed by modular units assembled in a flexible way to produce several configurations, that can meet aesthetic and functional requirements.

**F**\_Système de cloisons modulaires qu'on peut équiper avec accessoires. Archimede est un système ouvert formé d'éléments modulaires assemblés de manière flexible pour obtenir des configurations différentes qui peuvent satisfaire élégamment exigences esthétiques et fonctionnelles.

**D**\_Modulares Trennwandsystem, das mit verschiedenem Zubehör ausgestattet werden kann. Archimede ist ein offenes System, bestehend aus Modulelementen, die flexibel miteinander verbunden werden können, und in unterschiedlichen Zusammenstellungen elegant den ästhetischen und funktionellen Anforderungen jedes Projekts gerecht wird.

**E**\_Sistema de pantallas divisoras componibles y con accesorios. Archimede es un sistema abierto constituido por elementos modulares que ensamblan de manera flexible entre sí para generar diferentes configuraciones capaces de satisfacer de forma elegante exigencias estéticas y funcionales.



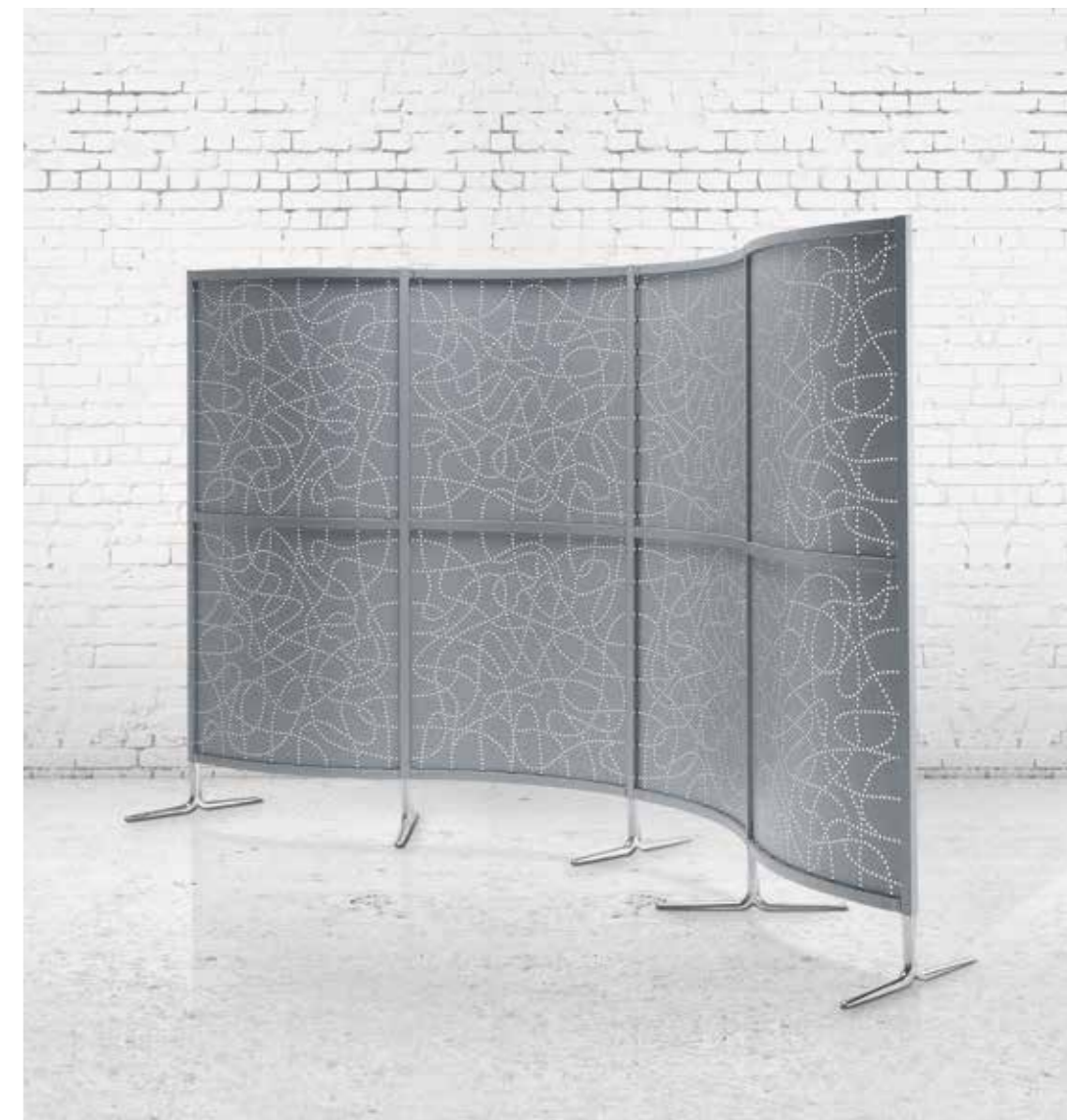
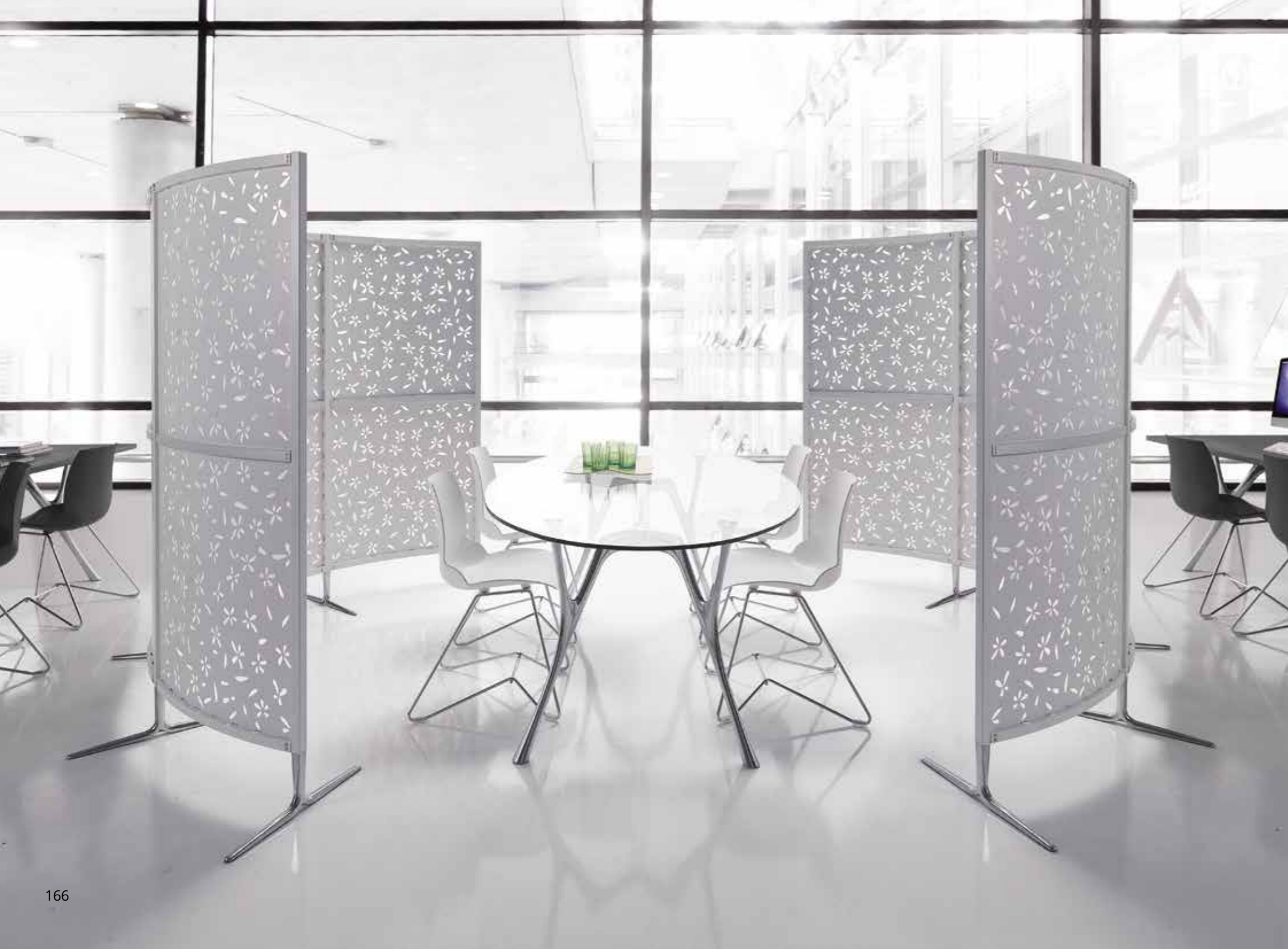

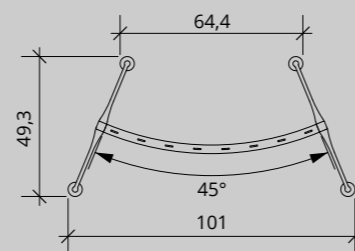
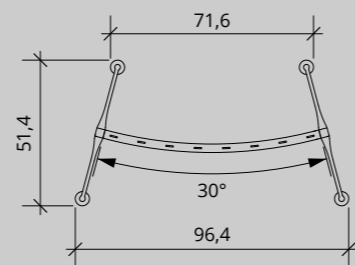
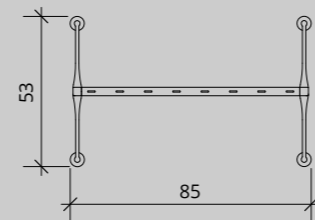
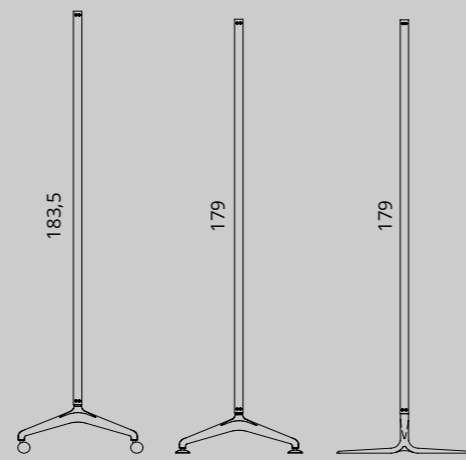

**I\_Montanti e traverse in acciaio verniciato con polveri epossidiche colore grigio argento o bianco opaco.**

**EN\_Uprights and crossbars in silver grey or mat white epoxy powder-coated steel.**

**F\_Montants et traverses en acier peint en époxy gris argenté ou blanc mat.**

**D\_Seitensteher und Traversen aus mit Epoxypulver beschichtetem Stahl, Farbe silbergrau oder mattweiß.**

**E\_Montantes y transversales en acero pintado con polvos epoxi color gris plata o blanco mate.**

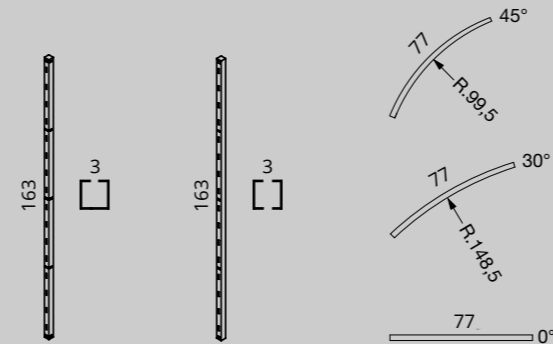

**I\_Basi in alluminio lucidato. Disponibili con piedini regolabili in tecnopolimero e acciaio zincato oppure con ruote piroettanti con e senza freno.**

**EN\_Bases in polished aluminum. Available with adjustable feet in high-tech polymer and zinc-coated steel or with swivel castors, with or without brake.**

**F\_Bases en aluminium poli. Disponibles avec pieds réglables en technopolymère et acier zingué ou avec roulettes pivotantes avec et sans frein.**

**D\_Standfüße aus poliertem Aluminium. Erhältlich mit verstellbaren Füßchen aus Technopolymer und verzinktem Stahl oder mit Lenkrollen mit und ohne Bremse.**

**E\_Bases de aluminio pulido. Disponibles con pies regulables de tecnopolímero y acero zincado o bien con ruedas pivotantes con y sin freno.**



**I\_Pannelli in tecnopolimero trasparente oppure in acciaio forato, microforato, bugnato o arabescato verniciato con polveri epossidiche.**

**EN\_Panels in transparent high-tech polymer or in perforated, microperforated or bossage-finish epoxy powder-coated steel.**

**F\_Panneaux en technopolymère transparent ou en acier perforé, microperforé, avec bossage ou arabesques, peint en époxy.**

**D\_Paneele aus transparentem Technopolymer oder Epoxypulver beschichtetem gelochtem oder bossiertem Stahl.**

**E\_Paneles en tecnopolymère transparente o en acero perforado, microperforado o bugnato pintado con polvos epoxi.**

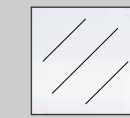
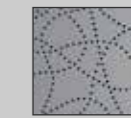
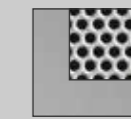

# BATTISTA Divider

Michele De Lucchi con Sezgin Aksu

**I**\_Sistema di elementi divisori Battista semplice, elegante e flessibile. Colonne realizzate in acciaio verniciato, basi in ghisa e particolari in acciaio cromato e alluminio lucidato. Telo fonoassorbente Snowsound Fiber textiles 1 batteriostatico (poliestere BIOACTIVE con ioni d'argento ad effetto antimicrobico permanente). Il sistema è sfoderabile.

**EN**\_System of partitions Battista, simple, elegant and flexible. Columns in epoxy-powder coated steel, cast iron bases and parts in chrome-plated steel and polished aluminum. Snowsound Fiber Textiles 1 bacteriostatic sound-absorbing sheet (BIOACTIVE polyester with silver ions with a permanent antimicrobial effect). The fabric slipcover is removable.

**F**\_Système de cloisons Battista, simple, élégant et flexible. Colonnes réalisées en acier peint, bases en fonte et détails en acier chromé et aluminium poli. Toile en phono-absorbant Snowsound Fiber Textiles 1 bactériostatique (polyester BIOACTIVE avec des ions d'argent à effet antimicrobien permanent). Le tissu est amovible.

**D**\_System mit einfachen, eleganten und flexiblen Battista Trennwänden. Säulen aus epoxy-pulverbeschichtetem Stahl, Fußring aus Gußeisen, weitere Bauteile aus verchromtem Stahl und poliertem Aluminium. Stoffbahn aus akustisch wirksamem und bakteriostatischem Snowsound Fiber Textiles 1 (BIOACTIVE Polyestermaterial mit dauerhaftem keimhemmenden Effekt durch Silberionen). Der Stoffbezug ist abnehmbar.

**E**\_Sistema de elementos divisores Battista sencillo, elegante y flexible. Columnas realizadas en acero pintado, bases de hierro fundido y detalles de acero cromado y aluminio lustrado. Tejido de Snowsound Fiber 1, fonoabsorbente y bacteriostático (poliéster BIOACTIVE con iones de plata con efecto antimicrobiano permanente). El sistema es desenfundable.



**SOUND ABSORBING TEXTILE**

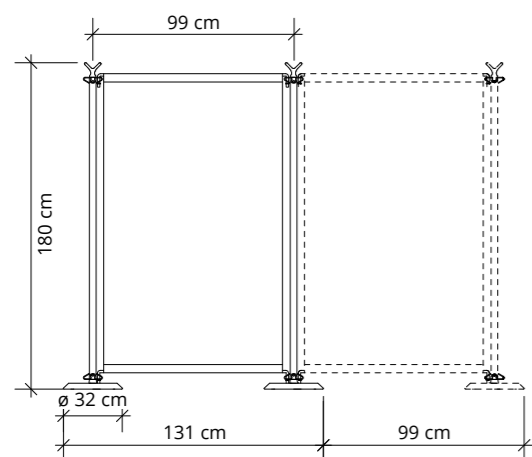

**BACTERIOSTATIC**



# SEPÀ ROLLS Safety

Sezgin Aksu

**I** Divisori fonoassorbenti realizzati con tessuto Snowsound Fiber Textiles 1 batteriostatico (poliestere BIOACTIVE con ioni d'argento ad effetto antimicrobico permanente) e strutture in tubolare di acciaio cromato montate su una sola base in tubolare che permette di accostare più divisori in linea o ad angolo. La base in tubolare è dotata di ruote poste alle estremità che ne consentono il facile spostamento. Il sistema è sfoderabile.

**EN** Sound absorbing dividers made with Snowsound Fiber Textiles 1 fabrics bacteriostatic (BIOACTIVE polyester with silver ions with a permanent antimicrobial effect) and chromed-plated tubular steel structures mounted on a single tubular base that allows you to juxtapose several dividers in line or creating a corner. The tubular base is equipped with wheels located at the ends that allow easy movement. The fabric slipcover is removable.

**F** Cloisons phono-absorbants réalisées en tissu Snowsound Fiber Textiles 1 bacteriostatique (polyester BIOACTIVE avec des ions d'argent à effet antimicrobien permanent) et structures en tube d'acier chromé montées sur une base unique plate en tubes que permet de disposer plusieurs cloisons en ligne droite ou en angle. La base en tube est munie de roulettes aux extrémités qui permettent un déplacement facile. Le tissu est amovible.

**D** Schallabsorbierende Trennwände aus Snowsound Fiber Textiles 1 bakteriostatischem (BIOACTIVE Polyestermaterial mit dauerhaftem keimhemmenden Effekt durch Silberionen), auf verchromten Stahlrohrrahmen mit Rollen. Mehrere Trennwände können in Reihe platziert oder übereck gestellt werden. Das Rohr am Boden ist an den Enden mit Rollen ausgestattet, die einfaches Umsetzen erleichtern. Der Stoffbezug ist abnehmbar.

**E** Mamparas divisorias fonoabsorbentes realizadas con tejidos Snowsound Fiber Textiles 1 bacteriostático (poliéster BIOACTIVE con iones de plata con efecto antimicrobiano permanente) y estructuras en tubular de acero cromado montadas sobre una única base en tubular que permite alinear varios divisorios o colocarlos formando un ángulo. La base en tubular dispone de ruedas ubicadas en los extremos por lo que es posible desplazarla fácilmente. El sistema es desenfundable.



**SOUND ABSORBING  
TEXTILE**



**BACTERIOSTATIC**





# SPEECH Divider

Angelotti & Cardile

**I**\_Divisorio mobile realizzato in acciaio cromato e caratterizzato dalla base in alluminio lucidato montata su ruote con freno, con telo in poliestere fonoassorbente Snowsound Fiber Textiles 3. Il sistema è sfoderabile.

**EN**\_A mobile divider consisting of a chrome-plated steel frame on a polished aluminum base mounted on lockable casters. The frame is fitted with Snowsound Fiber Textiles 3, a sound-absorbing polyester fabric. The fabric is removable and replaceable.

**F**\_Une cloison mobile en acier chromé et caractérisée par une base en aluminium poli montée sur des roues avec frein, avec une toile en polyester phono-absorbant Snowsound Fiber Textiles 3. Le système est amovible.

**D**\_Verstellbare Trennwand aus Chromstahl, die sich durch einen polierten Aluminium-Fuß auf Rollen mit Bremse und eine Leinwand aus schalldämpfendem Snowsound-Fiber-Textiles3-Gewebe auszeichnet. Das System ist ausziehbar.

**E**\_Mampara móvil que se caracteriza por su base de aluminio brillante montada sobre ruedas con freno, tejido de poliéster fonoabsorbente Snowsound Fiber Textiles 3. El sistema es desenfundable.



**SOUND ABSORBING  
TEXTILE**



123 x 60 x h 180 cm

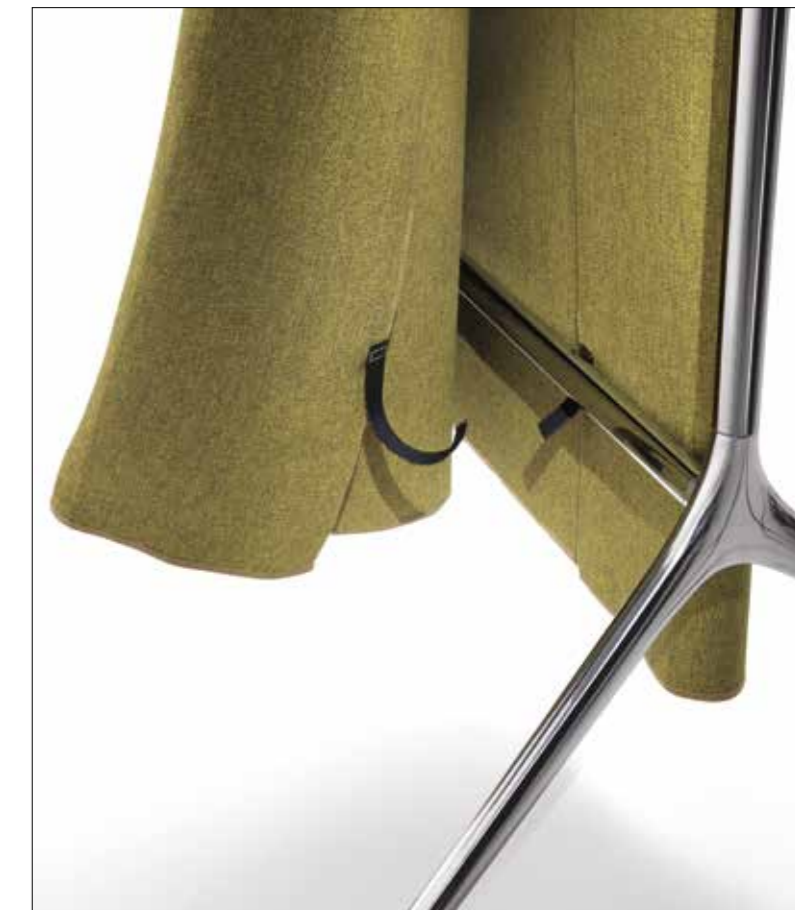
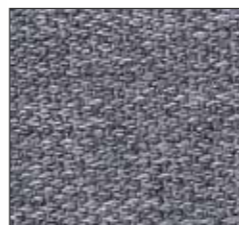

# ARIANNA Desk

Caimi Lab

**I**\_Arianna desk è un sistema modulare di schermi divisori flessibili. I pannelli sono fissati ai montanti tramite attacchi fissi o particolari attacchi magnetici che consentono l'aggancio/sgancio rapido del pannello. I pannelli sono in tecnopolimero trasparente mentre i montanti sono realizzati in acciaio verniciato con polveri epossidiche bianco opaco o grigio argento.

**EN**\_Arianna desk is a modular system with flexible partitions. Panels are attached to the uprights with either mechanical fixings or special magnetic fasteners that allow easy and quick installation/disassembly of the panels. Panels in transparent high-tech polymer. Uprights in matt white or silver grey powder-coated steel.

**F**\_Arianna desk est un système modulaire de cloisons flexibles. Les panneaux sont fixés aux poteaux par des attaches fixes ou des attaches magnétiques particulières qui permettent de les accrocher/décrocher rapidement. Panneaux en technopolymère transparent. Poteaux en acier époxy, blanc mat ou gris argenté.

**D**\_Arianna Desk ist ein modulares System mit flexiblen Paneelen. Die Paneele werden entweder mit mechanischen Befestigungen oder speziellen magnetischen Befestigungselementen an den Pfosten befestigt, die das schnelle Installieren / Entfernen der Paneele erleichtern. Paneele aus transparentem Hightech-Polymer. Pfosten aus mattweiß oder silbergrau pulverbeschichtetem Stahl.

**E**\_Arianna es un sistema expansible de mamparas flexibles. Los paneles van fijados a los montantes a través de soportes fijos o magnéticos especiales que permiten acoplar y desacoplar rápidamente el panel. Los paneles son de tecnopolímero transparente mientras los montantes son de de acero pintado con polvo epoxi color blanco mate o gris plata.

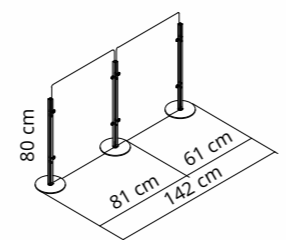
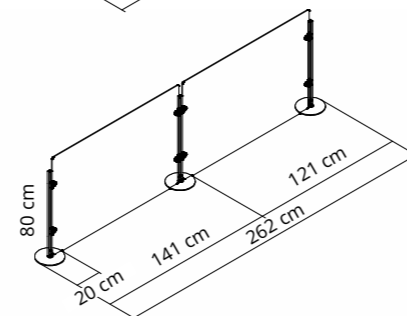
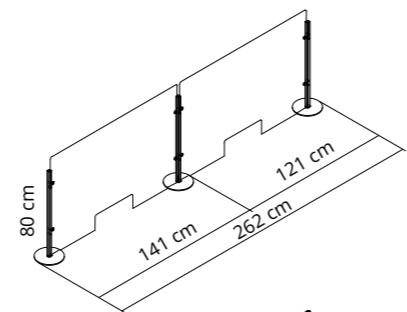
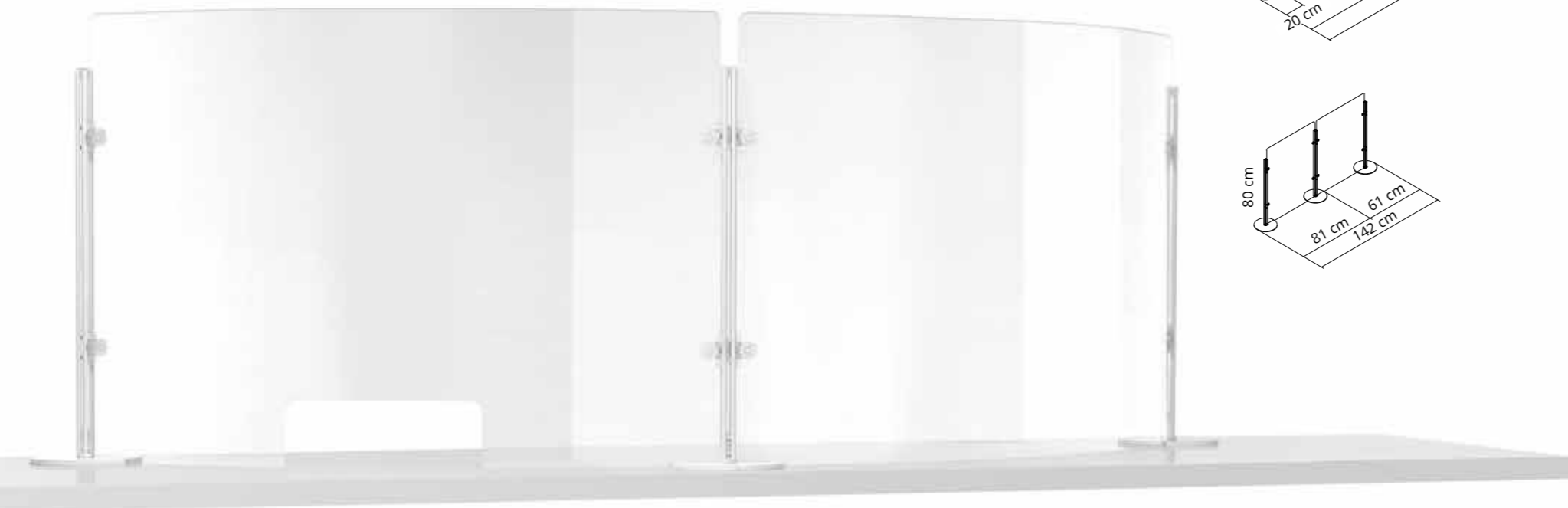

FIXED CONNECTORS



MAGNETIC CONNECTORS



# GEKO

Giulio Iacchetti

**I** Originale sistema decorativo, composto da un unico elemento in tecnopolimero a sei braccia, aggregabile all'infinito e secondo molteplici combinazioni. Ideale per separare spazi, per creare vivaci quinte e fondali o semplicemente per ravvivare e personalizzare gli ambienti.

**EN** An original decoration system formed by one six-arm component in high-tech polymer to be linked endlessly and according to several combinations. Perfect to divide spaces, create lively wings and backdrops or just to enliven and personalize a room.

**F** Système décoratif original breveté, formé d'un seul élément en technopolymère à six bras, qu'on peut assembler à l'infini et suivant plusieurs combinaisons. Idéal pour séparer l'espace, créer des coulisses mobiles et fonds ou simplement pour raviver et personnaliser les pièces.

**D** Originelles dekoratives, patentiertes System, das aus einem einzigen Element aus Technopolymer mit sechs Armen besteht, diese können mit einer Vielzahl von Kombinationen verwendet werden. Ideal für das Trennen von Räumen, das Erzeugen von lebhaften Vorhängen und Hintergründe oder einfach um die Räume zu beleben und persönlich zu gestalten.

**E** Original sistema decorativo patentado, compuesto por un único elemento de tecnopolímero de seis brazos, agregable infinitamente y según múltiples combinaciones. Ideal para separar espacios, para crear vistosas filas y fondos o simplemente para reavivar y personalizar ambientes.

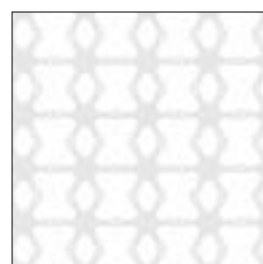
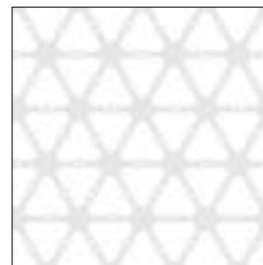

# GASTONE

Caimi Lab

**I** Originale elemento divisorio con colonnine laterali in acciaio ricoperte e collegate da un unico cordone flessibile in tecnopolimero. Basi in acciaio inox massiccio. Gastone è facilmente trasportabile, elegante e adatto ad ogni tipo di ambiente.

**EN** An original room divider with steel side stanchions covered and connected by a single flexible high-tech polymer cord. Solid stainless steel bases. Gastone is elegant, easily transportable, and suits any type of environment.

**F** Élément de séparation original avec des colonnes latérales en acier recouvertes et liées à un seul cordon flexible en technopolymère. Bases en acier inoxydable massif. Gastone est facile à transporter, élégant et approprié à tout type d'intérieur.

**D** Originelles Trennelement mit seitlichen überzogenen Stahlständern, welche durch ein einziges flexibles Seil aus technischem Kunststoff verbunden werden. Die Ständer sind aus massivem Edelstahl. Gastone ist leicht zu transportieren, elegant und eignet sich für jeden Raum.

**E** Elemento separador original con montantes laterales de acero revestidos y conectados con un cordón flexible único de tecnopolímero. Bases de acero inoxidable macizo. Gastone se puede desplazar fácilmente, es elegante y adecuado a todo tipo de ambiente.





# BATTISTA Stanchion

Michele De Lucchi con Sezgin Aksu

**I**\_Colonnine Battista con cordone in tecnopolimero e ganci in metallo cromato. La colonnina è realizzata in acciaio verniciato con polveri epossidiche e base in ghisa verniciata con polveri epossidiche o in acciaio inox, dettagli in alluminio lucidato e acciaio inox.

**EN**\_Battista columns with high-tech polymer cable and chrome-plated metal hooks. Column is in powder-coated steel with base in powder-coated cast iron or in stainless steel, details in polished aluminum or stainless steel.

**F**\_Colonnettes Battista avec cordon en technopolymère et crochets en métal chromé. La colonne est réalisée en acier peint en époxy et une base en fonte peinte en époxy ou en acier inox, détails en aluminium poli et acier inox.

**D**\_Battista Standsäulen mit Kordeln aus Technopolymer und verchromten Metallhaken. Die Säule ist aus pulverbeschichtetem Stahl mit Fuß bzw. Bodenplatte aus pulverbeschichtetem Gusseisen oder Edelstahl und Details aus poliertem Aluminium oder Edelstahl.

**E**\_Columnitas Battista con cordón de tecnopolimero y sujeciones de metal cromado. La columna es de acero pintado con polvos epoxi y la base realizada en fundición gris, va recubierta con polvos epoxi o en acero inox, detalles de aluminio brillante y acero inox.



**I** Colonnina Battista con nastro estensibile ottenuta mediante una sofisticata lavorazione del tubolare d'acciaio che viene conificato per poter passare da un  $\varnothing$  70 mm ad un  $\varnothing$  32 mm. Questa tecnologia permette di realizzare una colonnina dalla forma sinuosa, esile nella parte inferiore per ridurre l'impatto visivo. La colonnina è realizzata in acciaio verniciato con polveri epossidiche e base in ghisa verniciata con polveri epossidiche o in acciaio inox, dettagli in alluminio lucidato e acciaio inox.

**EN** Battista small column with retractable tape obtained through a sophisticated working of the steel tubular, which is cone-shaped to change from a 70 mm dia to 32 mm dia. This technology allows to carry out a sinuous column; thin in the lower part for a lower visual impact. The column is made of epoxy powder coated steel and cast iron base painted with epoxy powders or stainless steel, details in polished aluminum and stainless steel.

**F** Colonnette Battista avec ruban extensible obtenue au moyen d'un travail sophistiqué du tubulaire d'acier qui devient conique pour pouvoir changer de  $\varnothing$  70 mm à  $\varnothing$  32 mm. Cette technologie permet de réaliser une petite colonne à la forme sinueuse; mince dans la partie inférieure pour réduire l'impact visuel. La colonne est réalisée en acier peint en époxy et une base en fonte peinte en époxy ou en acier inox, détails en aluminium poli et acier inox.

**D** Der Battista kleine Säule mit ausziehbarem Band wird durch eine innovative Bearbeitung des Stahlrohrs erhalten. Der Battista Absperrpfosten mit Gurtkassette wird durch eine ausgefeilte Bearbeitung des Stahlrohrs in Kegelform geschaffen, wodurch der Durchmesser von 70 mm auf 32 mm verjüngt wird. Diese Technologie ermöglicht es, einen Absperrpfosten mit geschwungener Form zu erhalten, der im unteren Teil schlank ist, und dadurch eleganter wirkt. Die Standäule ist aus pulverbeschichtetem Stahl mit Fuß bzw. Bodenplatte aus pulverbeschichtetem Gusseisen oder Edelstahl und Details aus poliertem Aluminium oder Edelstahl.

**E** Columna Battista con cinta extensibile se obtiene mediante un sofisticado proceso del tubo de acero que se conifica para poder pasar de un  $\varnothing$  70 mm a un  $\varnothing$  32 mm. Esta tecnología permite realizar una columna de forma sinuosa, delgada en la parte inferior, para reducir el impacto visual. La columna es de acero pintado con polvos epoxi y base de hierro fundido pintado con polvos epoxi o en acero inoxidable, detalles en aluminio pulido y acero inoxidable.



# SET

Caimi Lab

**I** La serie di colonnine serventi Set è caratterizzata dalla linea pulita ed essenziale, focalizzata sull'estrema funzionalità degli elementi e dei materiali che la compongono, è pensata per tutti quegli ambienti, pubblici e privati, in cui è necessario dividere, separare e organizzare lo spazio, i percorsi e la comunicazione, in modo efficace, ma con un impatto visivo leggero e poco invasivo. Le finiture in acciaio inox satinato, abbinata ai particolari in nero gofrato e la cura del dettaglio sono gli elementi di design che caratterizzano questa collezione.

**EN** The defining characteristic of a stanchion from the Set series is its clean and austere linear configuration, which results from a design emphasis on the absolute functionality of its constituent elements and materials. Effective, yet also unobtrusive and visually inconspicuous, the stanchion is designed for public or private spaces that need to be divided, cordoned off or otherwise organized, as well as for access pathways and communication lines. The stanchions of this collection are notable for their satin stainless-steel finish, embossed black detailing, and meticulous design.

**F** La série de colonnettes multi-fonction Set se distingue par sa ligne épurée et essentielle, concentrée sur la fonctionnalité extrême des éléments et des matériaux qui la composent. Elle a été conçue pour tous les espaces publics et privés où il faut diviser, séparer et organiser l'espace, les parcours et la communication de manière efficace, avec un impact visuel léger et discret. Les finitions inox satiné, associées aux éléments noirs gaufrés et une attention particulière aux détails sont les caractéristiques du design qui distinguent cette collection.

**D** Die Standsäulen der Serie Set zeichnen sich durch ihre klaren und essenziellen Linien aus. Das hohe Maß an Funktionalität der verwendeten Elemente und Materialien ist für alle öffentlichen und privaten Räumlichkeiten gedacht, in denen der Raum, der Durchgang und die Kommunikation geteilt, getrennt und organisiert werden müssen – wirksam, aber auf kaum sichtbare und unaufdringliche Art. Das Finish aus mattem Edelstahl, die schwarz geprägtem Details und die Perfektion bei der Verarbeitung charakterisieren das Design dieser Kollektion.

**E** La colección de postes delimitadores Set se caracteriza por su línea limpia y esencial, apuesta por la absoluta funcionalidad de los elementos y materiales que la conforman y está pensada para todos aquellos ambientes, tanto públicos como privados, en los que es necesario dividir, separar, organizar el espacio, el guiado peatonal y la comunicación de forma eficaz, pero con un impacto visual ligero y discreto. Los acabados en acero inoxidable satinado combinados con componentes en negro gofrado y la atención al detalle son los elementos de diseño distintivos de esta colección.





**I\_Set** è costituita da una colonnina in acciaio inox satinato con base circolare, disponibile nelle finiture acciaio inox satinato o verniciata in colore nero gofrato. Sulla testa della colonnina si agganciano e si sganciano in modo semplice e rapido gli accessori tramite un innovativo sistema di innesto.

**EN\_Set** stanchion consists of a satin stainless-steel pole standing on a circular base, likewise finished in satin stainless steel but also available with an embossed black coating. Accessories can be quickly and easily attached to and detached from the pole head thanks to an innovative coupling system.

**F\_Set** est formé par un colonnette en acier finition inox satiné avec un pied circulaire, disponible en acier finitions inox satiné ou peint en noir gaufré. Sur la partie supérieure du colonnette les accessoires sont accrochés et décrochés rapidement et facilement grâce à un système d'ancrage innovant.

**D\_Set** besteht aus einem matten Edelstahlständer mit kreisförmigem Bodenplatte, verfügbar in den Varianten Edelstahl matt oder lackiert in geprägtem Schwarz. Oben auf dem Standsäule werden die Accessoires dank eines innovativen Stecksystems schnell und einfach angebracht oder abgenommen.

**E\_Set** está formada por un poste de acero inoxidable satinado con base circular, disponible con acabados en acero inoxidable satinado o recubierta en color negro gofrado. El cabezal del poste está dotado de un innovador sistema de fijación que permite enganchar y desenganchar los accesorios de forma sencilla y rápida.



**I**\_Elemento con 4 attacchi filettati per l'aggancio di corde elastiche. Realizzato in acciaio inossidabile satinato. Corda elastica con attacchi terminali a vite in acciaio e acciaio inossidabile.

**EN**\_Element with 4 threaded slots for the attachment elastic ropes. Made of satin stainless steel. Elastic ropes with screw-in end fitting made of steel and stainless steel.

**F**\_Élément avec 4 attaches filetées pour la fixation de cordes élastiques. Réalisé en acier inox satiné. Corde élastique avec attaches d'extrémité à vis en acier et en acier inox.

**D**\_Element mit 4 Vorrichtungen für das Einhängen von Expanderseilen. Aus mattem Edelstahl. Expanderseil mit schraubenförmigen Enden aus Stahl und Edelstahl.

**E**\_Elemento con 4 fijaciones de rosca para fijar cintas elásticas. Realizado en acero inoxidable satinado. Cinta elástica rematada con fijaciones de rosca en acero y acero inoxidable.

ø 30 x h 47,5 / 92,5 cm

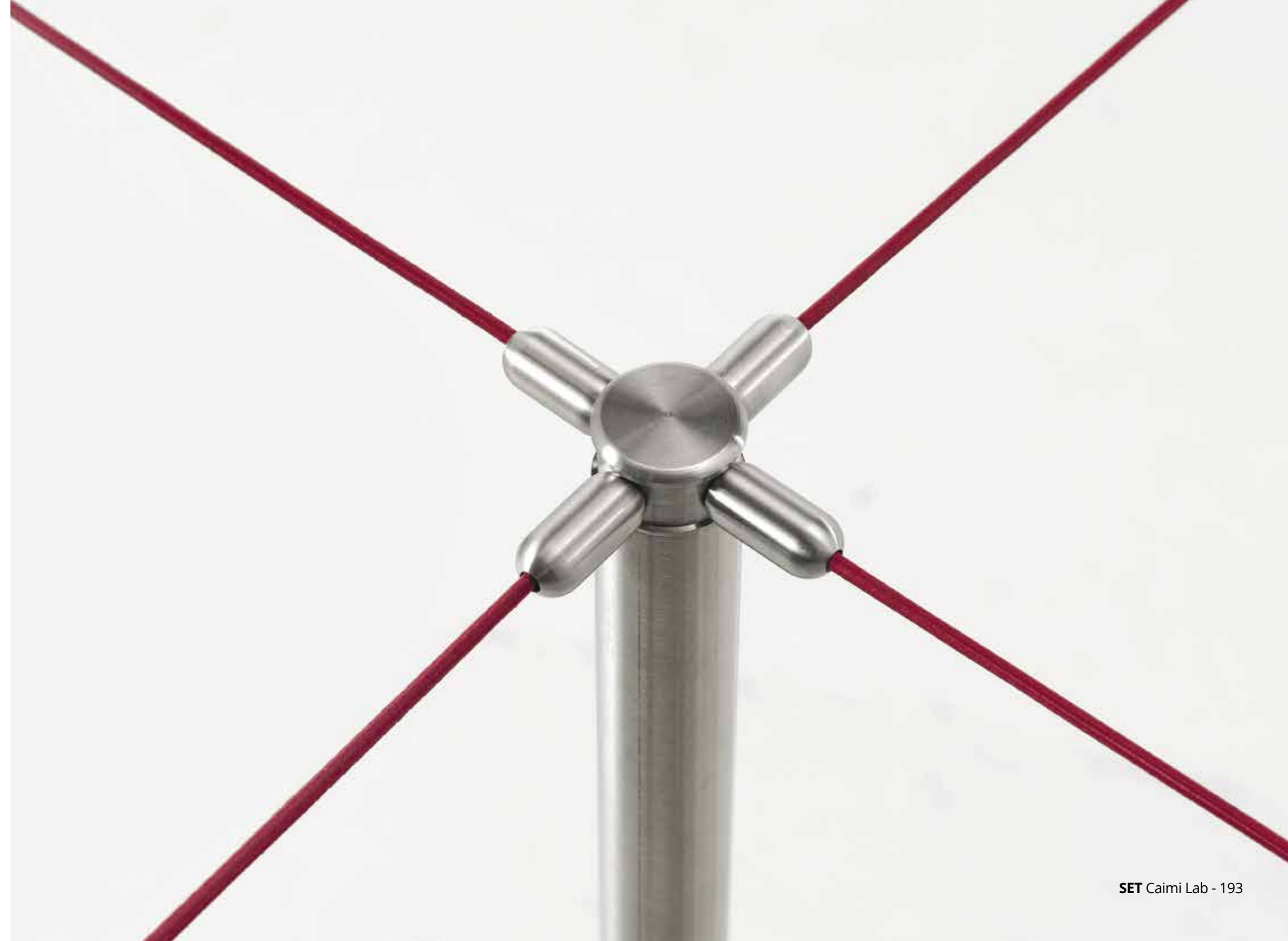

# SPEECH Barrier

Angelotti & Cardile

**I**\_Transenna divisoria realizzata in acciaio cromato e caratterizzata dalla base in alluminio lucidato montata su ruote con freno. Gli elementi sono collegabili tra loro tramite un cordone in tecnopolimero dotato di moschettoni alle estremità.

**EN**\_A room divider made of chrome-plated steel with a polished aluminum base mounted on lockable casters. The elements can be connected together by a high-tech polymer cord with snap-hook attachments.

**F**\_Séparateur en acier chromé et caractérisé par une base en aluminium poli montée sur des roues avec frein. Les éléments peuvent être reliés entre eux avec un cordon en technopolymère muni de crochets aux extrémités.

**D**\_Trennbarriere aus verchromtem Stahl, die sich durch einen polierten Stahlfuß auf Rollen mit Bremse auszeichnet. Die Elemente können durch ein Seil aus technischem Kunststoff miteinander verbunden werden, an deren Enden Karabiner befestigt sind.

**E**\_Mampara de separación de acero cromado que se compone por una base de aluminio brillante montada sobre ruedas con freno. Los elementos se pueden conectar mediante un cordón de tecnopolímero con mosquetones en los extremos.

192 x 60 x h 100 cm

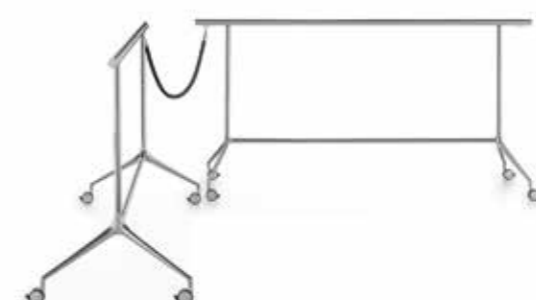
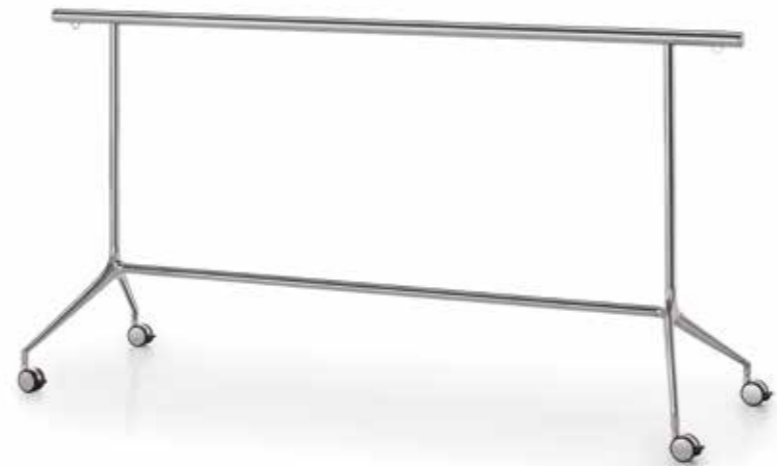



# KOALA

Michele De Lucchi con Sezgin Aksu

**I**\_Sistema brevettato di segnaletica e comunicazione composto da una serie completa di espositori e portadepliant in acciaio verniciato con polveri epossidiche e PET trasparente, disponibili in diversi formati. I morsetti di aggancio sono in tecnopolimero.

**EN**\_Patented sign and communication system formed by a complete line of displays and depliant holder in powder-coated steel and transparent PET, available in several sizes. Connecting clamps in high-tech polymer.

**F**\_Système breveté de signalétique et communication composé d'une gamme complète de présentoirs et porte-dépliants en acier peint en époxy et PET transparent, disponibles en plusieurs formats. Pincés d'accrochage en technopolymère.

**D**\_Patentiertes Schilder- und Kommunikationssystem. Eine komplette Linie von Schildern und Prospekthalter aus pulverbeschichtetem Stahl und transparentem PET, in vielen Grössen verfügbar. Befestigungen aus Technopolymer.

**E**\_Sistema patentado de señalización y comunicación compuesto por una serie completa de expositores y portafolletos en acero recubierto con polvo epoxi y PET transparente, disponibles en diversos formatos. Terminales de conexión en tecnopolimero.





A5 O - A5 V  
A4 O - A4 V  
A3 O - A3 V  
50x70 - 70x100

**I** Gli espositori sono liberamente applicabili su due cavi di acciaio con diverse opzioni di aggancio a parete e a soffitto.

**EN** Display units to freely mount on two steel cables with a variety of options for either wall or ceiling mounting.

**F** Les présentoirs peuvent être librement appliqués sur deux câbles en acier avec différentes options de fixation à la paroi et au plafond.

**D** Die Infotafeln können frei an zwei Stahlseilen mit verschiedenen Arten der Wand- oder Deckenbefestigung angebracht werden.

**E** Los expositores se pueden aplicar en dos cables de acero con diferentes soluciones para sujetarlos a la pared o al techo.



A6 O  
A5 O - A5 V  
A4 O - A4 V

**I** Espositori con fissaggio a parete in vetro mediante biadesivo.

**EN** Display units to mount to the glass wall with double-sided adhesive.

**F** Présentoirs à fixer à la paroi en verre avec une bande biadhésive.

**D** Infotafeln zur Glaswandbefestigung mit Klebestreifen.

**E** Expositores de vidrio con fijación de pared mediante cinta biadhesiva.



A6 O  
A5 O - A5 V  
A4 O - A4 V  
A3 O - A3 V  
50x70 - 70x100

**I** Espositori con fissaggio diretto a parete con viti.

**EN** Display units directly wall-mounted with screws.

**F** Présentoirs avec fixage par vis directement sur la paroi.

**D** Infotafeln mit direkter Wandbefestigung mit Schrauben.

**E** Expositores con fijación en muro directa mediante tornillos.



A5 O - A5 V  
A4 O - A4 V

**I** Espositori con supporto a bandiera in acciaio verniciato con polveri epossidiche, mono o bi-fronte.

**EN** Display units with flag style support in powder-coated steel, single- or double-sided.

**F** Présentoirs avec support type drapeau en acier peint en époxy, mono ou double-face.

**D** Infotafel mit fahnenförmiger Befestigung aus pulverbeschichtetem Stahl, ein- oder zweiseitig

**E** Expositores con soporte bandera en acero pintado con polvos epoxi mono o bifrontal.



15x7  
A5 O - A5 V  
A4 O - A4 V

**I** Espositori con base di appoggio in acciaio verniciato con polveri epossidiche.

**EN** Display units with powder-coated steel support base.

**F** Présentoirs avec base d'appui en acier peint en époxy.

**D** Infotafeln mit Ablagefläche aus pulverbeschichtetem Stahl

**E** Expositores con soporte de apoyo de acero pintado con polvo epoxi.



**I** Utilizzando i cavi in acciaio dotati di ganci in metallo cromato, Koala si trasforma in un sistema per appendere quadri, stampe, immagini ecc. facilmente applicabile a parete o a soffitto.

**EN** The special steel cables equipped with chrome-plated hooks transform Koala into a system for suspending paintings, prints, pictures from the wall or from the ceiling.

**F** Avec des crochets en métal chromé appliqués aux câbles en acier, Koala devient un système d'accrochage pour tableaux, gravures, images etc., simple à appliquer au mur ou au plafond.

**D** Durch spezielle Stahlseile mit verchromten Haken wird Koala in ein System verwandelt, mit dem man Photos, Gemälde und Drucke von Wänden oder Decken abhängen kann.

**E** Los cables de acero equipados con ganchos cromados transforman Koala en un sistema para suspender los cuadros, dibujos y pinturas de la pared o del techo.



Istituto Europeo di Design, Madrid (Spain)

# KOALA-T

Michele De Lucchi con Sezgin Aksu

**I**\_Sistema brevettato di segnaletica e comunicazione composto da una serie completa di espositori e portadepliant in metacrilato trasparente, disponibili in diversi formati. I morsetti di aggancio sono in tecnopolimero.

**EN**\_Patented sign and communication system formed by a complete line of displays and depliant holder in transparent methacrylate, available in several sizes. Connecting clamps in high-tech polymer.

**F**\_Système breveté de signalétique et communication composé d'une gamme complète de présentoirs et porte-dépliants en méthacrylate transparent, disponibles en plusieurs formats. Pinces d'accrochage en technopolymère.

**D**\_Patentiertes Schilder- und Kommunikationssystem. Eine komplette Linie von Schildern und Prospekthalter aus transparentem Methacrylat, in vielen Grössen verfügbar. Befestigungen aus Technopolymer.

**E**\_Sistema patentado de señalización y comunicación compuesto por una serie completa de expositores y portafolletos en metacrilato transparente, disponibles en diversos formatos. Terminales de conexión en tecnopolimero.







A5 O - A5 V  
A4 O - A4 V  
A3 O - A3 V  
50x70 - 70x100

I\_Espositori con fissaggio a parete in vetro mediante piastre in acciaio e biadesivo.

EN\_Display units to mount to the glass wall using plates with double-sided adhesive.

F\_Présentoirs avec fixation à la paroi en verre avec plaques en acier et bande biadhésive.

D\_Infotafeln mit Glaswandbefestigung durch selbstklebende Stahlplatten.

E\_Expositores de vidrio con fijación en pared mediante placas de acero y cinta biadhésiva.



A5 O - A5 V  
A4 O - A4 V  
A3 O - A3 V  
50x70 - 70x100

I\_Espositori con fissaggio diretto a parete con viti.

EN\_Display units directly wall-mounted with screws.

F\_Présentoirs avec fixation par vis directement sur la paroi.

D\_Infotafeln mit direkter Wandbefestigung durch Schrauben.

E\_Expositores con fijación en muro directa mediante tornillos.



A5 O - A5 V  
A4 O - A4 V  
A3 O - A3 V  
50x70 - 70x100

I\_Gli espositori sono liberamente applicabili su due cavi di acciaio con diverse opzioni di aggancio a parete e a soffitto.

EN\_Display units are freely applicable on two steel cables with different wall and ceiling attachment options.

F\_Les présentoirs peuvent être librement appliqués sur deux câbles en acier avec différentes options de fixation à la paroi et au plafond.

D\_Die Infotafeln können frei an zwei Stahlseilen mit verschiedenen Arten der Wand- oder Deckenbefestigung angebracht werden.

E\_Los expositores se pueden aplicar en dos cables de acero con diferentes soluciones para sujetarlos a la pared o al techo.



# ARCHIMEDE DISPLAY

Caimi Lab

**I** Le versioni su cavo d'acciaio di Koala e Koala-T sono compatibili con le strutture Archimede Display, sia mobili su ruote che fisse, realizzate in acciaio verniciato con polveri epossidiche.

**EN** Koala and Koala-T cable mounted display units are compatible with the Archimede Display structures, either moveable on casters or stationary, in powder-coated steel.

**F** Les versions sur câble d'acier de Koala et Koala-T sont compatibles avec les structures Archimede Display, mobiles sur roulettes ou fixes, réalisées en acier peint en époxy.

**D** Die Versionen von Koala und Koala-T an Stahlseilen sind mit den Zusammenstellungen von Archimede Display aus pulverbeschichtetem Stahl, feststehend oder auf Rollen, kombinierbar.

**E** Las versiones en cable de acero de Koala y Koala-T son compatibles con las estructuras Archimede Display móviles montadas sobre ruedas así como con las versiones fijas realizadas en acero pintado con polvos epoxy.



KOALA



KOALA-T



Villa Litta, Lainate (Milano - Italy)

# SET

Caimi Lab

**I**\_Set è costituita da una colonnina in acciaio inox satinato con base circolare, disponibile nelle finiture acciaio inox satinato o verniciata in colore nero gofrato. Sulla testa della colonnina si agganciano e si sganciano in modo semplice e rapido gli accessori tramite un innovativo sistema di innesto. Agganciando e sganciando gli accessori si possono facilmente riconfigurare le colonnine modificando le funzioni.

**EN**\_Set stanchion consists of a satin stainless-steel pole standing on a circular base, likewise finished in satin stainless steel but also available with an embossed black coating. Accessories can be quickly and easily attached to and detached from the pole head thanks to an innovative coupling system. Each stanchion can be reconfigured for different uses simply by attaching and detaching accessories.

**F**\_Set est formé par un colonnette en acier finition inox satiné avec un pied circulaire, disponible en acier finitions inox satiné ou peint en noir gaufré. Sur la partie supérieure du colonnette les accessoires sont accrochés et décrochés rapidement et facilement grâce à un système d'ancrage innovant. En accrochant ou en décrochant les accessoires on peut facilement reconfigurer les colonnettes en modifiant les différentes fonctions.

**D**\_Set besteht aus einem matten Edelstahlständer mit kreisförmigem Bodenplatte, verfügbar in den Varianten Edelstahl matt oder lackiert in geprägtem Schwarz. Oben auf dem Standsäule werden die Accessoires dank eines innovativen Stecksystems schnell und einfach angebracht oder abgenommen. Durch das An- und Abmachen der Accessoires können die Standsäulen und ihre Funktionen leicht verändert werden.

**E**\_Set está formada por un poste de acero inoxidable satinado con base circular, disponible con acabados en acero inoxidable satinado o recubierta en color negro gofrado. El cabezal del poste está dotado de un innovador sistema de fijación que permite enganchar y desenganchar los accesorios de forma sencilla y rápida. Al enganchar y desenganchar los accesorios, se consigue redefinir los postes fácilmente modificando las funciones.



# BATTISTA Totem

Michele De Lucchi con Sezgin Aksu

**I**\_Gli espositori del sistema Koala possono essere fissati in configurazioni mono o bi-fronte a colonne in acciaio verniciato con polveri epossidiche con basi in acciaio inox, in acciaio o in ghisa verniciati con polveri epossidiche.

**EN**\_Koala system display units can be fixed in single- or double-sided formats to powder-coated steel columns with bases in stainless steel or powder-coated cast iron or steel.

**F**\_Les présentoirs du système Koala peuvent être fixés en compositions mono ou double-face à des colonnes en acier peint en époxy avec des bases en acier inox, en acier ou en fonte peints en époxy.

**D**\_Die Infotafeln vom Koala-System können ein- oder zweiseitig auf Standsäulen aus pulverbeschichtetem Stahl mit Füßen aus Edelstahl, bzw. pulverbeschichtetem Stahl oder Gusseisen angebracht werden.

**E**\_Los expositores del sistema Koala pueden fijarse según las diferentes configuraciones mono o bi-frontales a columnas de acero pintado con polvos epoxi con bases de acero inox o de fundición gris con polvos epoxi.



# KOALA Totem

Michele De Lucchi con Sezgin Aksu

**I**\_Totem espositori con struttura in acciaio verniciato, espositori in acciaio e PETG trasparente, portadepliant in acciaio.

**EN**\_A display totem with an epoxy-coated steel tube upright supporting a display unit made from steel and transparent PET and/or supporting steel brochure/leaflet-holder.

**F**\_Présentoirs totem avec une structure en acier peint, présentoirs en acier et PETG transparent, porte-dépliants en acier.

**D**\_Auslageständer mit Chromstahlgestell, Auslagen aus Stahl und durchsichtigem PETG, Broschüren-Auslagen aus Stahl.

**E**\_Tótems con estructura de acero pintado, expositores de acero y de PETG transparente, portafolletos de acero.

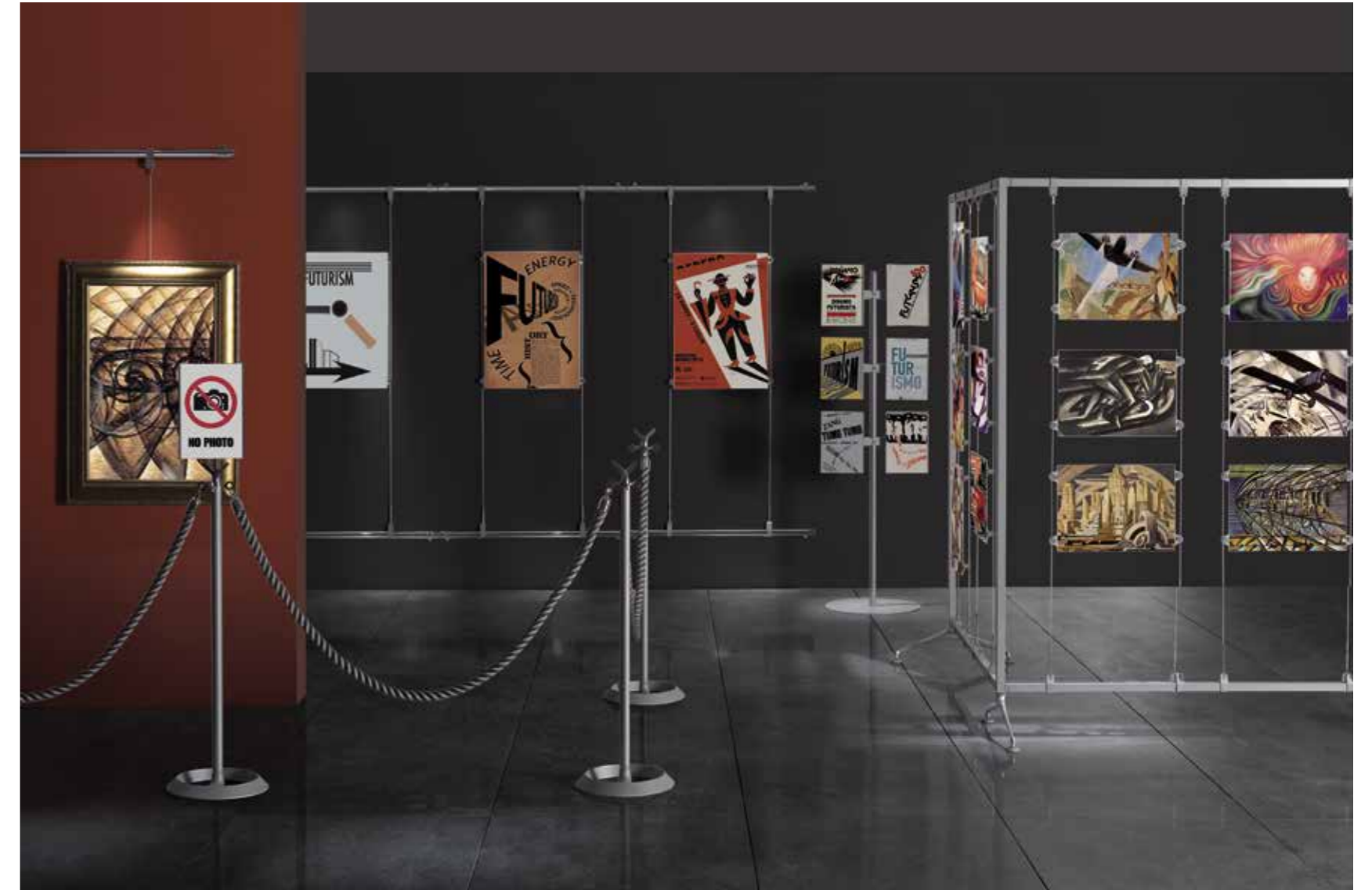

# MEETING

Caimi Lab

**I**\_Collezione di accessori per sale riunioni costituita da un profilo modulare a parete in alluminio satinato a cui si agganciano porta-tablet, portaoggetti, portabiti, lavagne in laminato e pannelli fonoassorbenti Snowsound.

**EN**\_Accessories for meeting rooms, comprised of a modular wall mounted frame in satin aluminum on which to install tablet mounts, holders, clothes hangers, laminate writing boards and Snowsound sound-absorbing panels.

**F**\_Collection d'accessoires pour salles de réunions avec profil modulaire à paroi en aluminium satiné pour accrocher les porte-tablettes, porte-objets, porte-manteau, tableaux en stratifié et panneaux anti-bruit Snowsound.

**D**\_Kollektion von Accessoires für Tagungsräume, bestehend aus einem modularen Profil zur Wandmontage aus satiniertem Aluminium, an dem Tablet-Halter, Ablagen für Gegenstände, Kleiderhaken, Schreibtafeln und schallabsorbierende Snowsound Paneele angebracht werden können.

**E**\_Colección de accesorios para salas de reunión compuesta por un marco de pared expansible en aluminio satinado donde colgar porta tabletas, portaobjetos, portatrajés, pizarras de laminado y paneles fonoabsorbentes Snowsound.

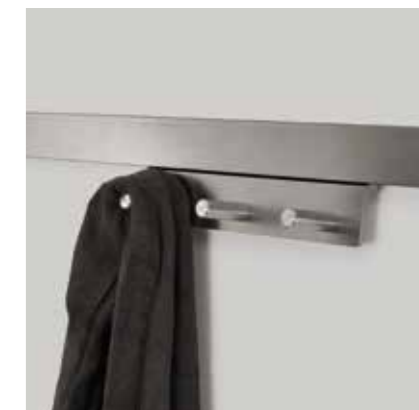
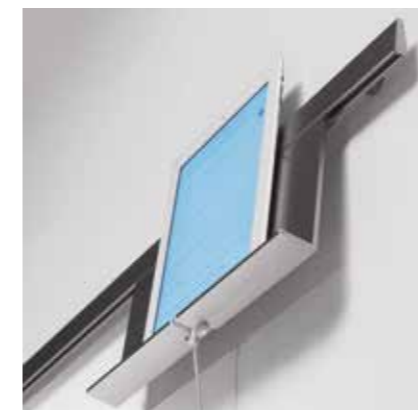

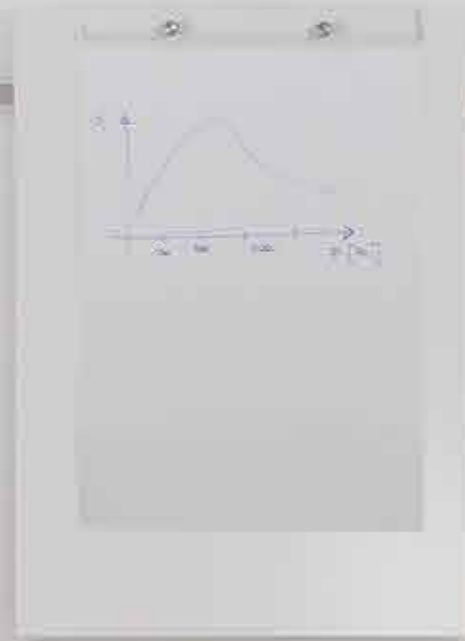

$$\frac{\partial^2 P(x,t)}{\partial x^2} = \frac{1}{G^2} \frac{\partial^2 P(x,t)}{\partial t^2}$$

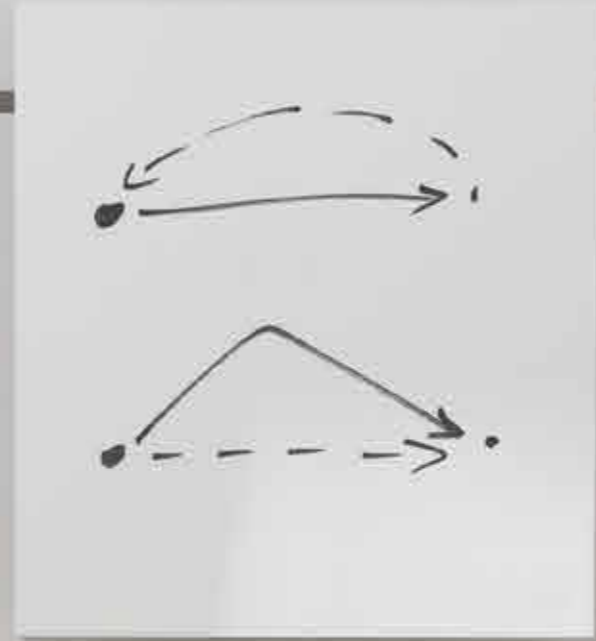

# SPEECH

Angelotti & Cardile

**I** Collezione di accessori ampia ed articolata, pensata per risolvere con un'unica linea coordinata le esigenze di ambienti polifunzionali, come sale riunioni e sale corsi. La collezione Speech prevede piani scrivibili in laminato, disponibili anche magnetici e completabili con pannello fonoassorbente, leggìo accessorabile in alluminio verniciato, divisorio fonoassorbente, portabiti stander e transenne divisorie. Tutti i prodotti sono caratterizzati dalla base in alluminio lucidato montata su ruote con freno e dalle strutture portanti in acciaio cromato.

**EN** A wide-ranging and rich assortment of coordinated accessories serving the needs of multifunctional environments, such as meeting rooms and lecture halls. The Speech collection includes writable laminate tops, also available as magnetic boards, sound-absorbing panels, accessorized lecterns in coated aluminum, sound-absorbing dividers, mobile clothes stands and room dividers. All the products are set on a base of polished cast aluminum mounted on lockable casters. The base supports a main structure made of chrome-plated steel.

**F** Une collection d'accessoires vaste et articulée, conçue pour résoudre avec une seule ligne coordonnée les besoins des lieux polyvalents, comme les salles de réunions et de cours. La collection Speech comprend des surfaces inscriptibles en stratifié, également en version magnétique à compléter par des panneaux phono-absorbant, pupitre de lecture avec accessoires en aluminium peint, cloison phono-absorbant, porte-manteaux et barrières de séparation. Tous les produits sont caractérisés par leur base en aluminium poli monté sur des roues avec frein et par les structures portantes en acier chromé.

**D** Eine breitgefächerte und artikulierte Kollektion an Zubehörelementen mit dem Ziel, durch eine einheitliche Produktlinie allen Anforderungen von Mehrzweckräumen wie Versammlungsräumen und Lehrräumen gerecht zu werden. Zur Speech-Kollektion gehören Schreibflächen aus Laminat (auf Wunsch magnetisch), die mit einer Schalldämpfplatte versehen werden können, ein mit Zubehör ausstattbarer Pult aus lackiertem Aluminium, schalldämpfende Trennwände, Kleiderständer und Trennbarrieren. Alle Produkte zeichnen sich durch den polierten Aluminiumfuss auf Rollen mit Bremse und durch ihr Chromstahlgestell aus.

**E** Colección amplia y diversificada de accesorios, concebida para solucionar con una línea única y coordinada las necesidades de los ambientes multifuncionales, como las salas de conferencias y las aulas de enseñanza. La colección Speech consta de superficies laminadas de escritura, también magnéticas, a las que se pueden añadir paneles fonoabsorbentes, un atril de aluminio pintado que se puede complementar, una mampara fonoabsorbente, un perchero stander y separadores de ambientes. Todos los productos se componen de una base de aluminio brillante montada sobre ruedas con freno y estructuras portantes de acero cromado.



218

123 x 60 x h 190 cm



73 x 60 x h 190 cm



73 x 60 x h 190 cm



67 x 60 x h 120 cm



123 x 60 x h 180 cm



123 x 60 x h 180 cm

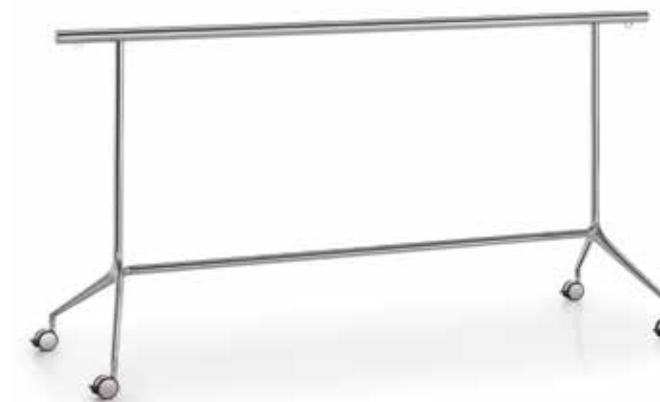

192 x 60 x h 100 cm

219

# SPEECH Write

Angelotti & Cardile

**I** Piani scrivibili in laminato con struttura in acciaio cromato e caratterizzati dalla base in alluminio lucidato montata su ruote con freno. I piani scrivibili possono essere completati con un elemento fonoassorbente applicabile tramite Velcro alla parte posteriore del piano, realizzato in tessuto acustico Snowsound Fiber Textiles con imbottitura in fibre di poliestere. Il Tessuto è asportabile e lavabile.

**EN** Writable laminate tops supported by a chrome-plated steel structure set on a polished aluminum base mounted on lockable casters. The writable tops can be fitted with a sound-absorbing element attachable using a velcro strip at the back. The element is made from Snowsound Fiber Textiles with polyester fiber padding. Removable and washable fabric.

**F** Surfaces inscriptibles en stratifié avec structure en acier chromé et caractérisée par une base en aluminium poli montée sur des roues avec frein. Les surfaces inscriptibles peuvent être complétées par un élément phono-absorbant applicable avec du Velcro sur la partie postérieure de la surface, réalisé en tissu acoustique Snowsound Fiber Textiles avec rembourrage en fibres de polyester. Le tissu est amovible et lavable.

**D** Laminat-Schreibfläche mit Chromstahlgestell. Der polierte Aluminiumfuss ist auf Rollen montiert und mit Bremse versehen. Die Schreibflächen können durch eine mit Polyester gefütterte Schalldämpf-Platte aus Snowsound-Fiber-Textiles-Gewebe versehen werden, die durch Klettverschluss an der Rückseite befestigt wird. Abnehmbares und waschbares Gewebe.

**E** Superficies laminadas de escritura con estructura de acero cromado, que se componen de una base de aluminio brillante montada sobre ruedas con freno. Las superficies para escribir se pueden completar con un elemento fonoabsorbente de tejido acústico Snowsound Fiber Textiles acolchado con fibras de poliéster, que se adhiere mediante Velcro a la parte posterior de la superficie. El tejido es extraíble y lavable.

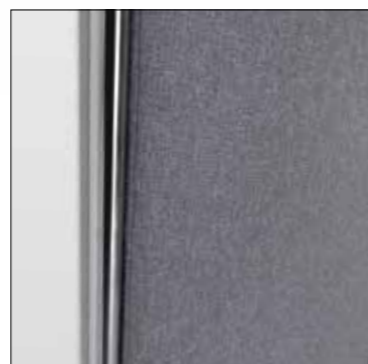

**SOUND ABSORBING  
PANEL**

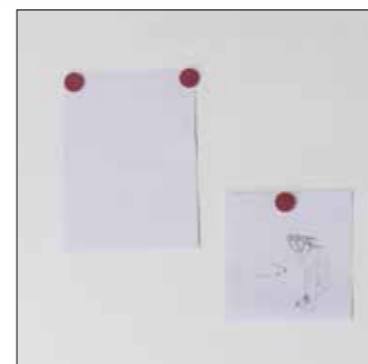



# SPEECH Lectern

Angelotti & Cardile

**I** Il leggio è accessoriabile con vaschetta per l'alloggiamento dei cavi, completo di anelli passacavi in tecnopolimero applicabili alla struttura.

**EN** The Speech bookstand can be accessorized with a tray for organizing power cords, complete with high-tech polymer rings to fasten to the frame.

**F** Le podium peut être équipé d'un bac pour placer les câbles, équipé par des anneaux passe-câbles en technopolymère applicables à la structure.

**D** Das Rednerpult kann mit Kabelwanne und ringförmigen Kabelschläuchen aus Technopolymer ergänzt werden.

**E** El atril se puede complementar con una bandeja para el alojamiento de cables con anillos pasacables de tecnopolimero aplicables a la estructura.

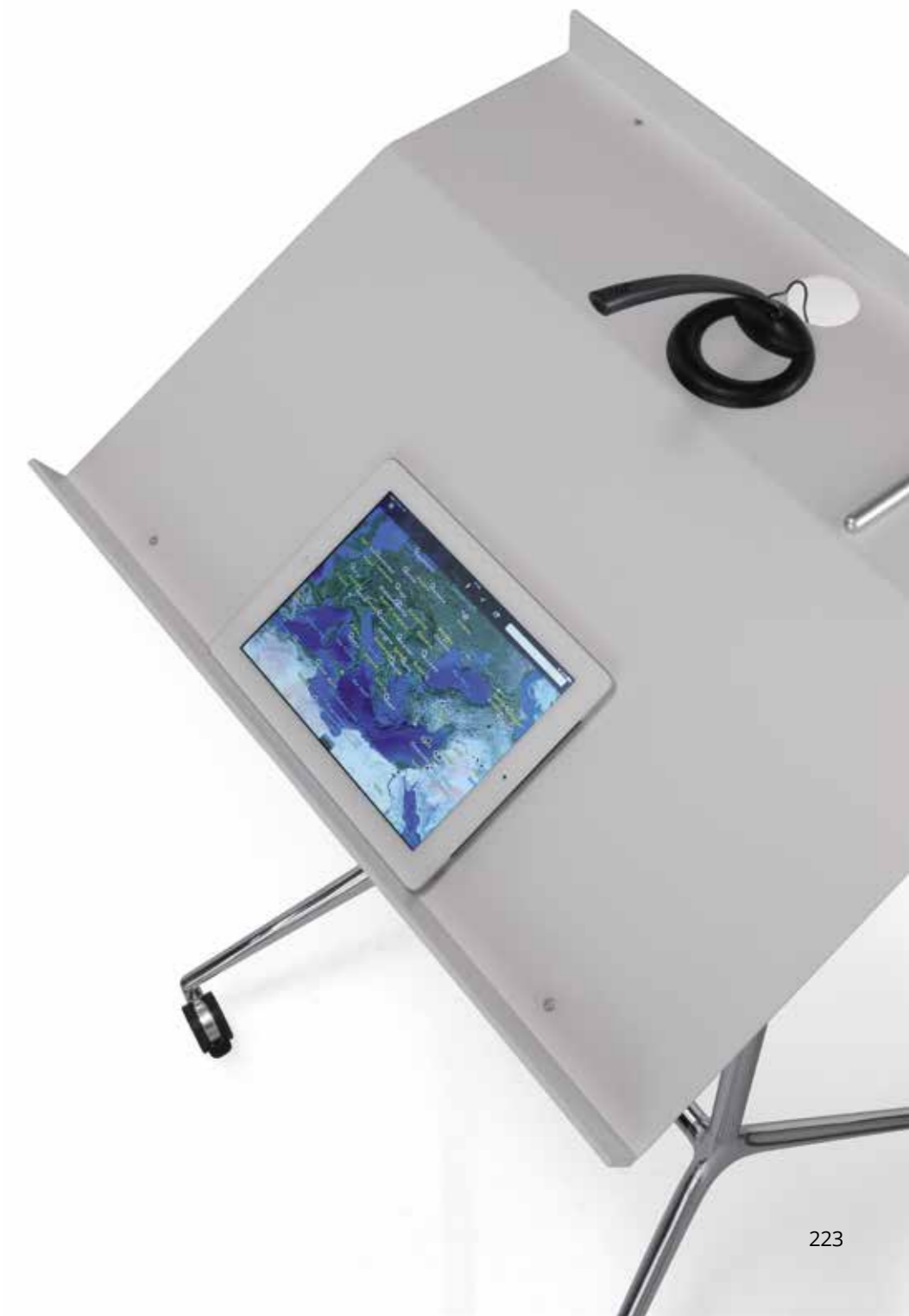



# ACCESSORIES

**I** Serie di complementi d'arredo, appendiabiti, cestini, portaombrelli, accessori per scrivania, progettati per ambienti collettivi o domestici, contraddistinti da un design in grado di soddisfare le differenti esigenze di gusto personale e di utilizzo. Oggetti adatti a piccoli o grandi spazi, minimalisti o di forte impatto. La differenza è nel dettaglio.

**EN** Series of furnishing accessories, coat hangers, baskets, umbrella stands, desk accessories, designed for public areas or the home and capable of catering to different needs, tastes and uses. Suitable for small as for large spaces, the accessories look good in a minimalist setting or may be used instead to make a strong visual impact. The difference is in the detail.

**F** Une série d'accessoires d'ameublement, porte-manteaux, corbeilles à papier, porte-parapluies, accessoires de bureau, conçus pour les lieux collectifs ou domestiques, caractérisés par un design capable de répondre aux exigences de style et d'utilisation. Des objets appropriés à des espaces petits ou grands, minimalistes ou de prestige. La différence est dans les détails.

**D** Eine Einrichtungszubehör-Reihe, zu der Kleiderständer, Papierkörbe, Schirmablagen, Schreibtischzubehör gehören, die für öffentliche und private Räume entworfen wurden und sich durch ein Design auszeichnen, das den unterschiedlichen Anforderungen in puncto Geschmack und Raumfunktion genügen kann. Objekte für kleine oder große Räume, minimal oder von großer Auswirkung. Der Unterschied steckt im Detail.

**E** Serie de complementos de decoración, percheros, papeleras, paragüeros y accesorios para escritorio, concebidos para entornos públicos o domésticos, que se caracterizan por un diseño que logra atender a la variedad de gustos personales y necesidades de uso. Objetos adecuados para espacios pequeños y grandes, minimalistas o de gran impacto. La diferencia estriba en el detalle.

# MET'ALL

Sezgin Aksu

I\_Portabiti a piantana interamente in metallo. Testa in zama e tubo centrale in acciaio cromato o verniciato con polveri epossidiche. Base in acciaio verniciato con polveri epossidiche o in acciaio inox lucido.

EN\_Standing coat stand. Head in zamak and central post in chrome-plated or powder-coated steel. Powder-coated steel or polished stainless steel base.

F\_Portemanteau sur pied entièrement en métal. Tête en zamak et tube central en acier chromé ou peint en époxy. Base en acier peint en époxy ou en acier inox brillant.

D\_Vollständig aus Metall gefertigter Garderobenständer. Kopf aus Zamak und Standsäule aus verchromtem oder pulverbeschichtetem Stahl. Fuß aus Stahl mit Epoxidpulverlackierung oder aus poliertem Edelstahl.

E\_Perchero de pie realizado en metal. Cabezal de zamak y cilindro central de acero cromado o pintado con polvos epoxi. Base de acero recubierta con polvos epoxi o en acero inox brillante.

ø 30 x h 163 cm



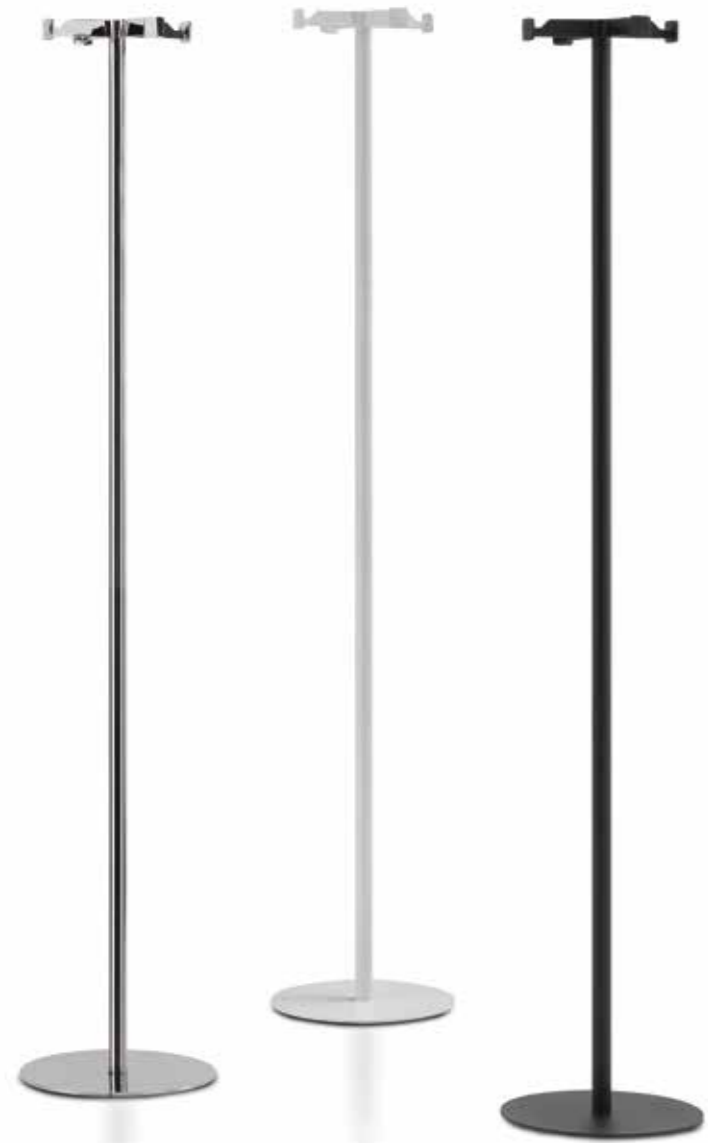

# SWING

Claudio Bellini

**I**\_Portabiti a piantana con struttura in acciaio verniciato con polveri epossidiche. Teste in policarbonato. Anello portaombrelli e vaschetta raccogliocce asportabili in tecnopolimero.

**EN**\_Coat stands with stem in epoxy painted steel. Heads in polycarbonate. Removable umbrella ring and drip tray in high-tech polymer.

**F**\_Portemanteau avec corps en acier peint en époxy. Têtes en polycarbonate. Anneau porte-parapluies et réceptacle amovibles en technopolymère.

**D**\_Garderobenständer mit Standsäule aus pulverbeschichtetem Stahl. Kopfteil aus Polykarbonat. Demontierbare Schirmhalterung und Abtropftrasse aus Technopolymer.

**E**\_Perchero de pie con estructura en acero pintado con polvos epoxídicos. Cabezas en policarbonato. Aro paraguero y cubeta recoge aguas exportables en tecnopolímero.



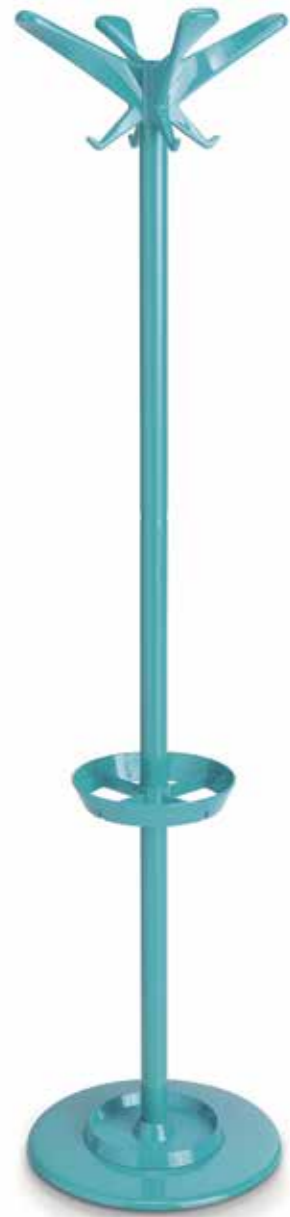

# QUADRANGOLO

Sezgin Aksu, Silvia Suardi

**I**\_Portabiti a piantana con tubo centrale a sezione quadrata e base realizzati in acciaio verniciato con polveri epossidiche finitura bianco opaco o verniciato finitura legno. La testa è realizzata in policarbonato finitura bianco opaco.

**EN**\_Coat stand with a central, square-section tube and base carried out in powder-coated steel, mat white finish or paint wood finish. The head is in mat white polycarbonate.

**F**\_Portemanteau avec tube central à section carrée et base réalisés en acier peint époxy, finition blanc mat ou peint finition bois. La tête est en polycarbonate, finition blanc mat.

**D**\_Garderobenständer mit quadratischer Standsäule und Bodenplatte aus pulverbeschichtetem Stahl in mattweiß oder Holzdekor. Der Kopf ist aus Polycarbonat, mit weiß-mattem Finish.

**E**\_Percheros de pie con tubo central de sección cuadrada y base de acero pintado con polvo epoxi acabado blanco mate o pintado acabado madera. La cabeza es de policarbonato acabado blanco mate.



35 x 35 x h 164 cm





# GIOIA

I\_Portabiti a piantana con struttura in acciaio verniciato con polveri epossidiche. Teste in policarbonato. Anello portaombrelli e vaschetta raccogliogocce asportabili in tecnopolimero.

EN\_Coat stands with stem in epoxy painted steel. Heads in polycarbonate. Removable umbrella ring and drip tray in high-tech polymer.

F\_Portemanteaux avec corps en acier peint en époxy. Têtes en polycarbonate. Anneau porte-parapluies et réceptacle emportables en technopolymère.

D\_Kleiderständer mit Struktur aus mit Epoxypulvern beschichtetem Stahl. Kopfteil aus Polycarbonat. Demontierbarer Schirmhalterung und Wassersammelbecken aus Technopolymer.

E\_Perchero de pie con estructura en acero pintado con polvos epoxídicos. Cabezas en policarbonato. Aro paragüero y cubeta recoge aguas exportables en tecnopolímero.



ø 39 x h 167 cm



# ELK

Angelotti & Cardile

I\_Portabiti a piantana con struttura in acciaio verniciato con polveri epossidiche. Teste in tecnopolimero. Anello portaombrelli e vaschetta raccogliogocce asportabili in tecnopolimero.

EN\_Coat stands with stem in epoxy painted steel. Heads in high-tech polymer. Removable umbrella ring and drip tray in high-tech polymer.

F\_Portemanteaux avec corps en acier peint en époxy. Têtes en techno-polymère. Anneau porte-parapluies et réceptacle amovibles en technopolymère.

D\_Garderobenständer mit Standsäule aus pulverbeschichtetem Stahl. Kopfteil aus Technopolymer. Demontierbare Schirmhalterung und Abtropftrasse aus Technopolymer.

E\_Perchero de pie con estructura en acero pintado con polvos epoxídicos. Cabezas en tecnopolímero. Aro paragüero y cubeta recoge aguas exportables en tecnopolímero.

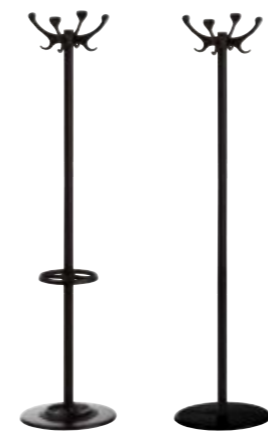

ø 39 x h 165 cm



# EVA

Caimi Lab

**I**\_Portabiti a piantana con struttura in acciaio verniciato con polveri epossidiche. Teste in tecnopolimero. Anello portaombrelli asportabile in tecnopolimero.

**EN**\_Coat stands with stem in epoxy painted steel. Heads in high-tech polymer. Removable umbrella ring in high-tech polymer.

**F**\_Portemanteaux avec corps en acier peint en époxy. Têtes en techno-polymère. Anneau porte-parapluies amovibles en techno-polymère.

**D**\_Garderobenständer mit Standsäule aus pulverbeschichtetem Stahl. Kopfteil aus Technopolymer. Demontierbare Schirmhalterung aus Technopolymer.

**E**\_Perchero de pie con estructura en acero pintado con polvos epoxídicos. Cabezas en tecnopolímero. Aro paraguero exportable en tecnopolímero.



ø 39 x h 164 cm



# KING

Angelotti & Cardile

**I**\_Portabiti a piantana con struttura in acciaio verniciato con polveri epossidiche. Teste in tecnopolimero. Anello portaombrelli e vaschetta raccogliogocce asportabili in tecnopolimero.

**EN**\_Coat stands with stem in epoxy painted steel. Heads in high-tech polymer. Removable umbrella ring and drip tray in high-tech polymer.

**F**\_Portemanteaux avec corps en acier peint en époxy. Têtes en techno-polymère. Anneau porte-parapluies et réceptacle amovibles en techno-polymère.

**D**\_Garderobenständer mit Standsäule aus pulverbeschichtetem Stahl. Kopfteil aus Technopolymer. Demontierbare Schirmhalterung und Abtropftrasse aus Technopolymer.

**E**\_Perchero de pie con estructura en acero pintado con polvos epoxídicos. Cabezas en tecnopolímero. Aro paraguero y cubeta recoge aguas exportables en tecnopolímero.



ø 39 x h 172 cm

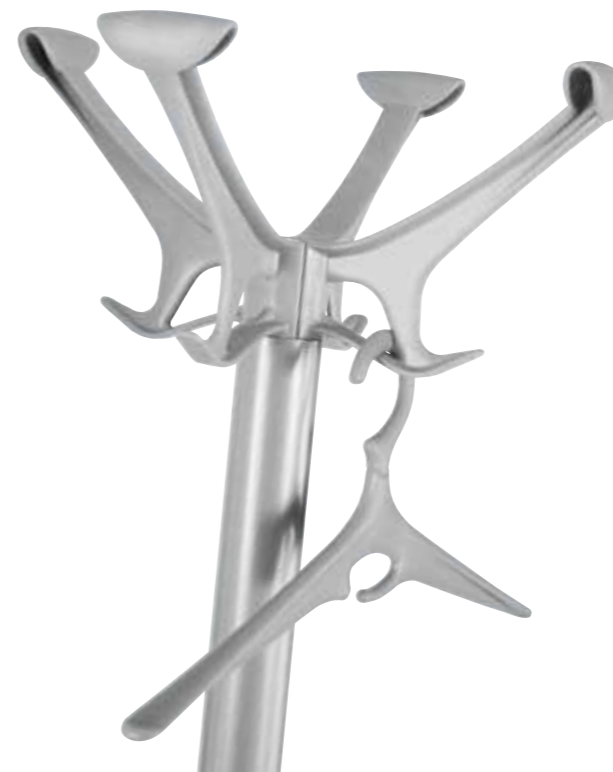

# MAESTRALE

Massimo Colagrande

**I**\_Portabiti realizzato in legno multistrato tinto ebano, con pomoli in metallo tornito color bronzo.

**EN**\_Coat stand in ebony finish plywood, with bronze finish turned metal knobs.

**F**\_Portemanteau réalisé en bois multicouches teinté ébène, avec pommeaux en métal tourné couleur bronze.

**D**\_Garderobenständer aus Schichtholz mit Ebenholzoptik und Knöpfen aus bronzefarbenem gedrehtem Metall.

**E**\_Perchero realizado en madera multicapa teñida color ebano, con pomelos de metal torneado color bronce.

ø 55 x h 161 cm



# BATTISTA Color

Michele De Lucchi con Sezgin Aksu

I\_Portabiti con testa in alluminio pressofuso verniciato con polveri epossidiche, tubo e base in acciaio verniciato con polveri epossidiche.

EN\_Coat stand with head made of epoxy powder-coated die-cast aluminum, and with uprights and a base made of epoxy powder-coated steel.

F\_Porte-vêtements avec tête en aluminium coulé sous pression peint en époxy, tuyau et bases en acier peint en époxy.

D\_Kleiderständer mit pulverbeschichtetem Aluguss-Kopfelement, Gestell und Fuß aus pulverbeschichtetem Stahl.

E\_Perchero con cabezal de aluminio fundido pintado con polvos epoxi, tubo y base de acero pintado con polvos epoxi.



ø 30 x h 161 cm





# BATTISTA

Michele De Lucchi con Sezgin Aksu

**I**\_I portabiti e i portaombrelli Battista sono realizzati in alluminio pressofuso e acciaio verniciato con polveri epossidiche, mentre le basi sono in ghisa verniciata con polveri epossidiche o in acciaio inox.

**EN**\_The Battista coat stand and umbrella stand are in die-cast aluminum and epoxy powder-coated steel, while the bases are in epoxy powder-coated cast iron or stainless steel.

**F**\_Les portemanteaux et porte-parapluies Battista sont en aluminium moulé sous pression et acier peint en époxy, tandis que les bases sont en fonte peinte en époxy ou en acier inox.

**D**\_Die Garderobe- bzw. Schirmständer Battista aus Aluminiumguss und pulverbeschichtetem Stahl verfügen über Standfüße aus pulverbeschichtetem Gusseisen oder aus Edelstahl.

**E**\_Los percheros y paragüeros Battista son de aluminio fundido y acero pintado con polvos epoxi. Las bases están realizadas en fundición gris recubierta con pinturas epoxi o son de acero inox.



ø 32 x h 165 cm    ø 32 x h 60 cm



ø 35 x h 161 cm    ø 35 x h 54 cm





**I**\_Portabiti Battista realizzato in alluminio pressofuso e acciaio verniciato finitura legno, base in acciaio inox.

**EN**\_Battista coat stand in die-cast aluminum and wood-finish coated steel, with stainless steel base.

**F**\_Portemanteau Battista en aluminium moulé sous pression et acier peint finition bois, base en acier inox.

**D**\_Kleiderständer Battista aus Aluminiumguss und lackiertem Stahl mit Holzfinish und Bodenplatte aus Edelstahl.

**E**\_Percheros Battista construido en aluminio fundido y acero pintado con "acabado madera", la base está realizada en acero inox.



ø 35 x h 161 cm

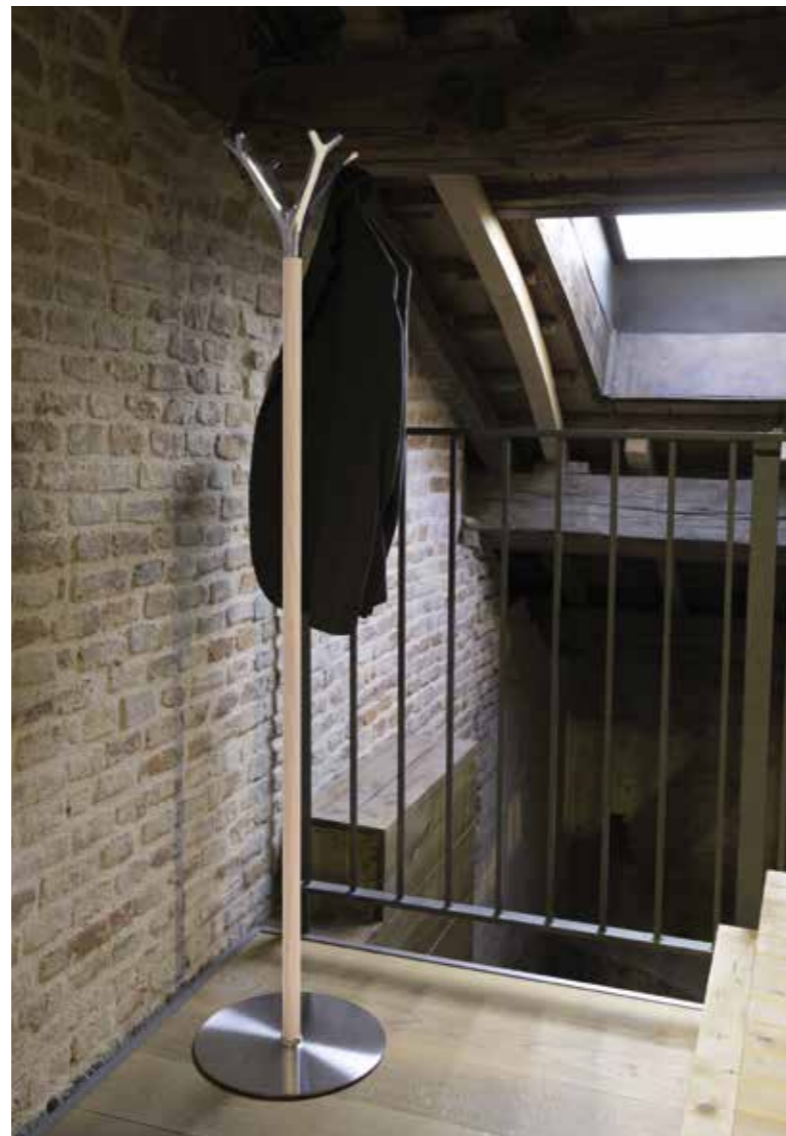

**I**\_Portabiti da parete in alluminio lucidato

**EN**\_Polished aluminum wall hanger.

**F**\_Portemanteau mural en aluminium poli.

**D**\_Garderobehaken aus poliertem Aluminium.

**E**\_Perchas de pared en aluminio pulido.

9 x 8 x h 15 cm





# SWING

Claudio Bellini

**I**\_Portabiti a parete modulare in acciaio cromato con ganci in tecnopolimero lucido.

**EN**\_Chrome-plated modular wall-mounted coat rail with glossy high-tech polymer.

**F**\_Portemanteau mural modulaire en acier chromé avec crochets en technopolymère brillant.

**D**\_Modulare Wandgarderobe mit Haken aus glänzendem Technopolymer.

**E**\_Percheros de pared modular en acero cromado con ganchos en tecnopolimero brillante.

45 x 10 x h 14 cm

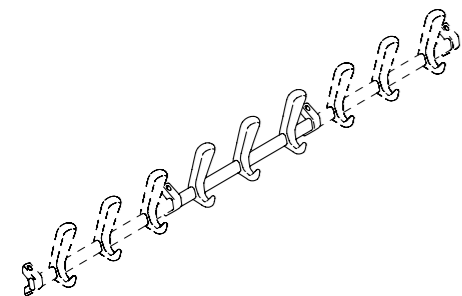

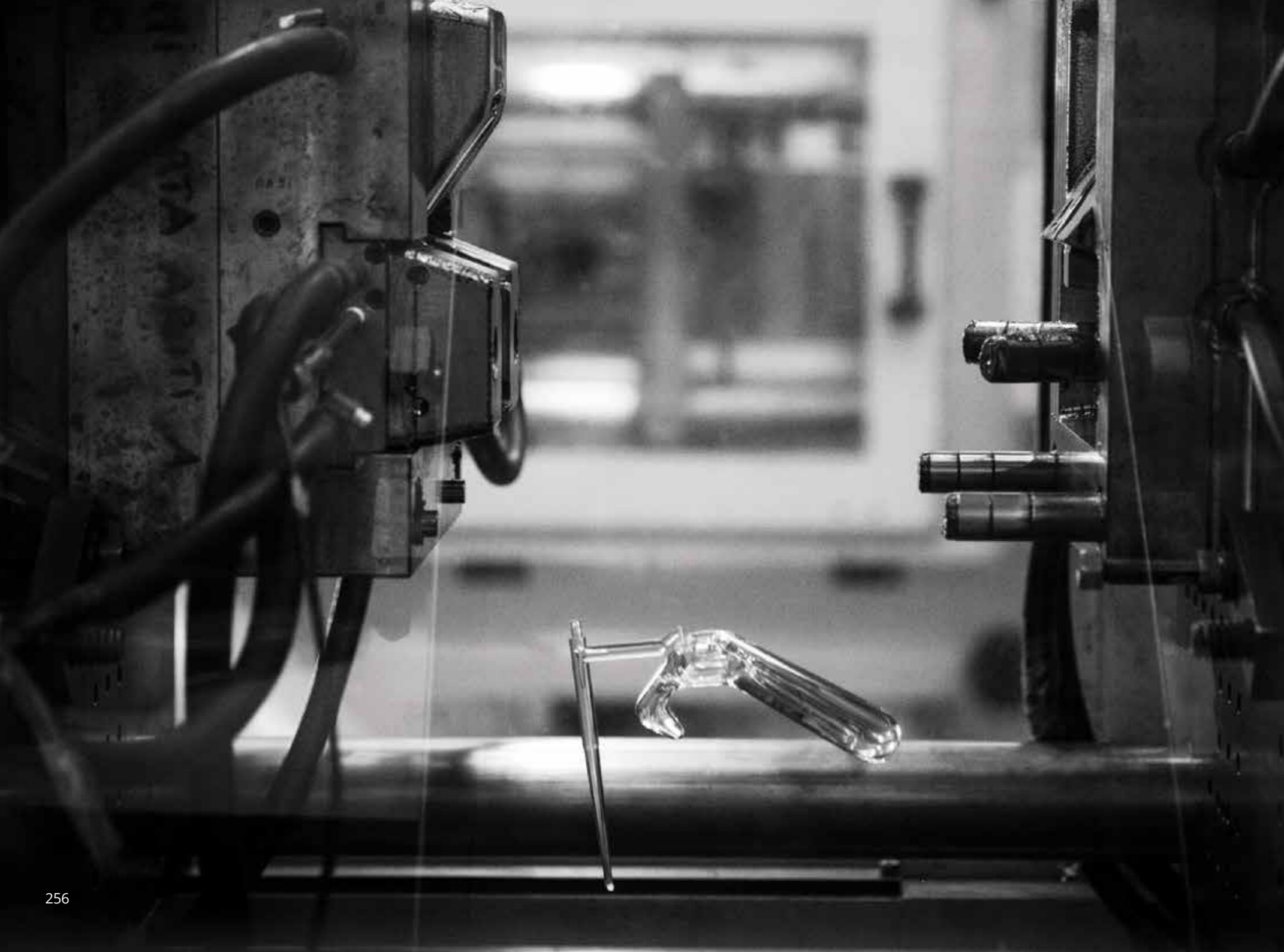

# HOOK

Raffaello Manzoni

**I**\_Portabiti a parete modulare in acciaio cromato con ganci in tecnopolimero o policarbonato.

**EN**\_Chrome-plated modular wall-mounted coat rail with high-tech polymer or polycarbonate hooks.

**F**\_Portemanteau mural modulaire en acier chromé avec crochets en technopolymère ou polycarbonate.

**D**\_Modulare Wandgarderobe mit Haken aus Technopolymer oder Polycarbonat.

**E**\_Percheros de pared modular en acero cromado con ganchos en tecnopolimero o policarbonado.

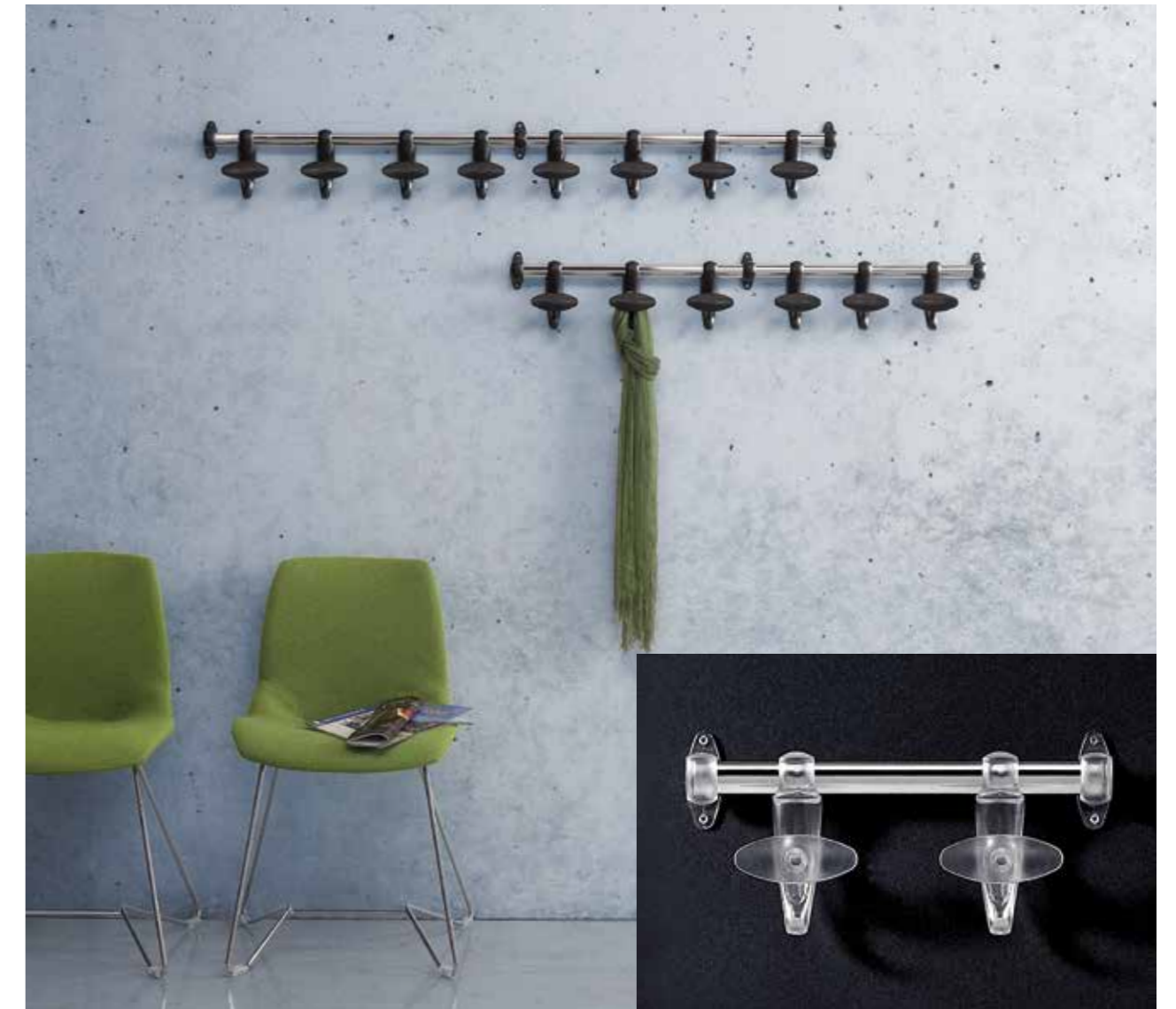
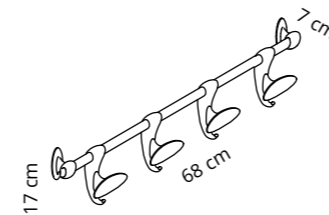
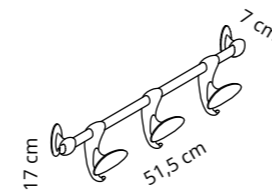
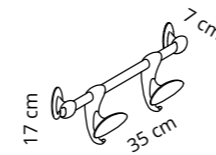

# PEDONE

Caimi Lab

**I**\_Portabiti da parete in metallo verniciato con polveri epossidiche e cromato.

**EN**\_HPowder-coated and chrome-plated steel wall hanger.

**F**\_Portemanteau mural en acier peint en époxy et chromé.

**D**\_Wandgarderobe aus mit Epoxypulver beschichtetem und verchromtem Stahl.

**E**\_Perchas de pared en en acero pintado con polvos epoxídicos y cromado.

ø 2,5 x 5,5 cm



# AMANITA

Giulio Iacchetti

**I**\_Portabiti da parete in tecnopolimero.

**EN**\_High-tech polymer wall hanger.

**F**\_Portemanteau mural en technopolymère.

**D**\_Wandgarderobe aus Technopolymer.

**E**\_Perchas de pared en en tecnopolímero.

ø 7 x 7 cm



# DUO

Angelotti & Cardile

**I**\_Portabiti a parete modulare in tecnopolimero.

**EN**\_High-tech polymer modular wall-mounted coat rail.

**F**\_Portemanteau mural modulaire en technopolymère.

**D**\_Wandgarderobe aus Technopolymer.

**E**\_Perchero de pared modular en tecnopolímero.

30 x 6 x h 12,5 cm



# AMBROGIO / AMBROGINO

Angelotti & Cardile

**I** Sistemi componibili di portabiti a parete realizzati in alluminio lucido e acciaio cromato.

**EN** Systems of wall-mounted coat rails in polished aluminum and chrome-plated steel.

**F** Systèmes modulaires de portemanteaux muraux en aluminium poli et acier chromé.

**D** Modulares Wandgarderobesystem aus glänzendem Aluminium und verchromtem Stahl.

**E** Sistemas componibles de perchas de pared en aluminio brillante y acero cromado.

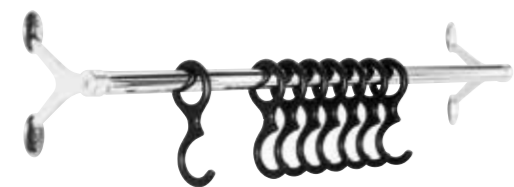

AMBROGINO

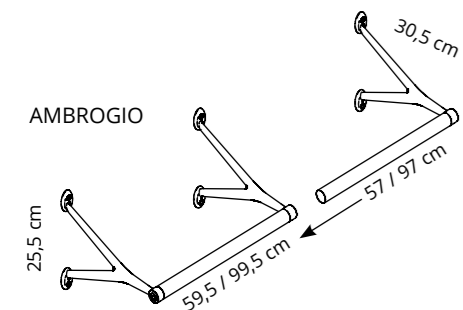
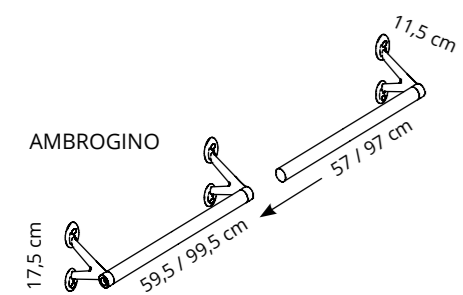

AMBROGIO



# OMETTO / HANGER

Angelotti & Cardile / Claus Breinholt

I\_Gruce appendiabiti in tecnopolimero.

EN\_High-tech polymer coat hangers.

F\_Cintres pour vêtements en technopolymère.

D\_Kleiderbügel aus Technopolymer.

E\_Perchas para ropa en tecnopolímero.



41,5 cm



7 cm

OMETTO



42 cm

HANGER

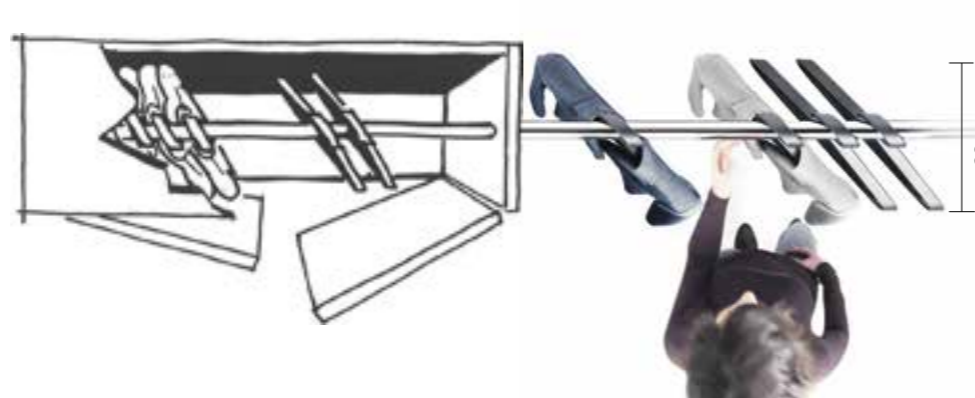

28 cm



# ARCHISTAND

Caimi Lab

**I**\_Stander portabiti, su ruote o fisso, in acciaio verniciato con polveri epossidiche, acciaio cromato e alluminio.

**EN**\_ Wheeled or fixed clothes stander in powder-coated steel, chrome-plated steel and aluminum.

**F**\_Portemanteau sur roulettes ou fixe en acier peint en époxy, acier chromé et aluminium.

**D**\_Kleiderständer auf Rädern oder feststehend, aus pulverbeschichtetem Stahl, verchromtem Stahl und Aluminium.

**E**\_Barra perchero, sobre ruedas o fijo, de acero pintado con polvo epoxi, acero cromado y aluminio.

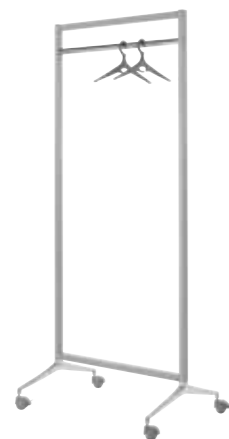

86 / 146 x 53 x h 185 cm



86 / 146 x 53 x h 180 cm



# SPEECH Stander

Angelotti & Cardile

**I**\_Stander portabiti realizzato in acciaio cromato e caratterizzato dalla base in alluminio lucidato montata su ruote con freno.

**EN**\_A mobile clothes stand made of chrome-plated steel tubes fixed to a polished aluminum base with lockable casters.

**F**\_Portemanteau sur roulettes en acier chromé caractérisée par sa base en aluminium poli montée sur des roues avec frein.

**D**\_Kleiderständer aus Chromstahl mit einem polierten Aluminiumfuss auf Rollen und mit Bremse.

**E**\_Perchero Stander de acero cromado que se compone de una base de aluminio brillante montada sobre ruedas con freno.

123 x 60 x h 180 cm

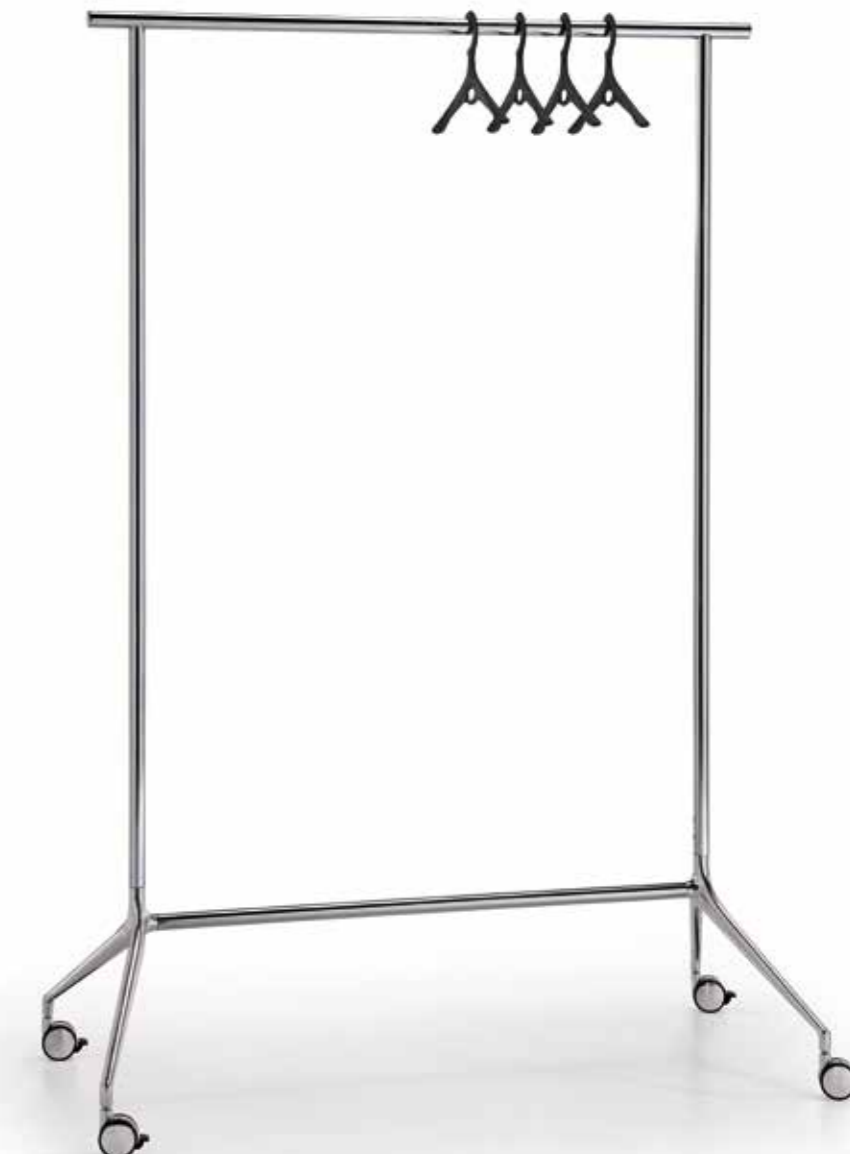

# SWING

Claudio Bellini

**I**\_Cestino gettacarte realizzato in tecnopolimero lucido.

**EN**\_Waste paper basket carried out in glossy high-tech polymer.

**F**\_Corbeille à papier réalisée en technopolymère brillant.

**D**\_Papierkörbe aus glänzendem Technopolymer.

**E**\_Papelera de tecnopolímero brillante.



25 x 25 x h 32 cm



# HI-TECH

Caimi Lab

I\_Cestini gettacarte in polipropilene.

EN\_Waste paper baskets in polypropylene.

F\_Corbeilles à papier en polypropylène.

D\_Papierkörbe aus Polypropylen.

E\_Papeleras de polipropilene.



ø 28 x h 35 cm







## DIVIDO

Caimi Lab

**I**\_Cestino per la raccolta differenziata interamente realizzato in tecnopolimero. Il cestino è fornito di serie con un divisorio interno e relativo fermasacchetto superiore liberamente posizionabili ad incastro permettendo di ottenere vani con la capienza desiderata.

**EN**\_Bin for recycling made entirely of technopolymer. It comes with an internal partition and accompanying bag holder at the top, both of which can be freely positioned allowing for compartments with the desired capacity.

**F**\_Corbeille pour le tri des déchets entièrement réalisée en technopolymère. La corbeille est dotée, de série, d'un séparateur interne avec support de sac supérieur, encastrables dans différentes positions pour obtenir des compartiments de la contenance souhaitée.

**D**\_Abfallbehälter zur Mülltrennung, komplett aus Technopolymer. Der Eimer wird serienmäßig mit einer internen Trennwand und entsprechender Müllbeutel-Halterung an der Oberseite geliefert. Diese sind anhand von Klemm-Mechanismen frei positionierbar, so dass die Behälter das gewünschte Fassungsvermögen erhalten.

**E**\_Cesto completamente de tecnopolímero para la separación de residuos. Se suministra con un divisorio interno y la correspondiente sujeción superior de serie. Estos pueden encajarse libremente, pudiendo así obtener los espacios con la capacidad necesaria.



44,5 x 22 x h 31 cm



# DESIGN COLLECTION

Caimi Lab

**I**\_Gettacarte e portaombrelli realizzati interamente in acciaio verniciato con polveri epossidiche.

**EN**\_Powder-coated steel wastepaper baskets and umbrella stands.

**F**\_Corbeilles à papier et porte-parapluies réalisés en acier peint en époxy.

**D**\_Papierkörbe und Schirmständer aus mit Epoxypulver beschichtetem Stahl.

**E**\_Papeleras y paragueros realizados en acero pintado con polvos epoxídicos.

20 x 20 x h 32 / 50 cm

35 x 20 x h 50 cm



# HI-TECH

Caimi Lab

**I**\_Cestini gettacarte e portaombrelli realizzati in acciaio verniciato con polveri epossidiche. Anello superiore e base in tecnopolimero.

**EN**\_Powder-coated steel wastepaper baskets and umbrella stands. Upper ring and base in high-tech polymer.

**F**\_Corbeilles à papier et porte-parapluies réalisés en acier peint en époxy. Anneau supérieur et base en techno-polymère.

**D**\_Papierkörbe und Schirmständer aus pulverbeschichtetem Stahl. Boden und Oberkante aus Technopolymer.

**E**\_Papeleras y paragüeros realizados en acero pintado con polvos epoxídicos. Aro superior y base en tecnopolímero.



ø 25 x h 32 cm



ø 25 x h 50 cm



# PIOGGIA

Caimi Lab

**I**\_Portaombrelli a rastrelliera realizzato in acciaio verniciato con polveri epossidiche, le vaschette raccogli acqua possono essere posizionate a due altezze per contenere sia ombrelli normali che ombrelli pieghevoli. Le due ruote in tecnopolimero facilitano le operazioni di trasporto.

**EN**\_Umbrella-rack in epoxy-painted steel, the drip trays can be fixed at two heights for both ordinary and folding umbrellas. The two castors in high-tech polymer make the moving easier.

**F**\_Porte-parapluies à râtelier en acier peint époxy, les réceptacles peuvent être positionnés à deux hauteurs pour contenir les parapluies normaux comme pliables. Les deux roulettes en technopolymère facilitent le déplacement.

**D**\_Schirmständer-Gestell aus mit Epoxidpulver beschichtetem Stahl, die Abtropfwannen können auf zwei Höhen verstellt werden, für sowohl normale Schirme als auch für Klappschirme. Die zwei Räder aus Technopolymer erleichtern den Transport.

**E**\_Paragüero con soportes de acero pintado con polvo epoxi, los recogeaguas pueden colocarse en dos alturas diferentes para contener tanto los paraguas clásicos como los plegables. Las dos ruedas de tecnopolimero facilitan las operaciones de transporte.

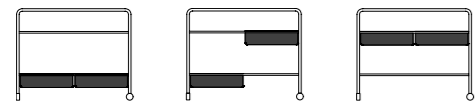

69 x 21,5 x h 55 cm



# SET

Caimi Lab

**I**\_Colonnina portaborse in acciaio inossidabile satinato, base in acciaio con rivestimento superiore in acciaio inossidabile satinato o verniciato con polveri epossidiche nero gofrato. Utilizzabile come pratico portaborse e come porta buste per ombrelli.

**EN**\_A bag holder consisting of a stanchion made of brushed stainless steel set on a steel base overlaid with satin-finished stainless steel or black embossed epoxy powder-coated steel. It can be used as a practical bag holder or as a wet umbrella bag holder.

**F**\_Colonne porte-sac en acier inoxydable satiné, base en acier avec revêtement supérieur en acier inoxydable satiné ou peint en époxy noir gaufré. A utiliser comme pratique porte-sac ou comme porte-sachets pour parapluies.

**D**\_Mattierter Edelstahlhalter für Taschen, Stahlfuß mit Überguss aus mattiertem Edelstahl oder geprägt und mit schwarzer Epoxidstaublackierung. Kann als praktische Ablage für Taschen und Tüten oder für Regenschirmhüllen verwendet werden.

**E**\_Poste para colgar bolsas realizado en acero inoxidable satinado, con base de acero con acabado superior de acero inoxidable satinado o pintado con polvos epoxi en color negro gofrado. Muy práctico para colgar bolsas o fundas para paraguas.

ø 30 x h 93 cm



# KABO

Alessandro Zambelli

**I**\_Originale portaombrelli realizzato in gres colorato, ottenuto con una particolare lavorazione a colatura.

**EN**\_An original looking umbrella stand made of colored stoneware, obtained by means of a special casting process.

**F**\_Porte-parapluie original en grès coloré, obtenu à partir d'un moulage particulier.

**D**\_Originelle Schirmablage aus farbigem Steingut, durch ein besonderes Gießverfahren hergestellt.

**E**\_Paragüero original de gres de colores, realizado con un proceso especial de encolado.

46 x 32 x h 15 cm



# MAXI

Caimi Lab

**I**\_Cestini ideati per la raccolta differenziata, il fusto e la base sono realizzati in acciaio verniciato con polveri epossidiche e sono dotati di coperchio asportabile in tecnopolimero disponibile in vari colori.

**EN**\_Bins designed for waste recycling, drum and the base are made from epoxy powder-coated steel: they are equipped with removable cover made from technopolymer available in various colours.

**F**\_Corbeilles conçues pour le tri des déchets, le fût et la base sont en acier peint époxy. Elles sont munies d'un couvercle amovible en technopolymère disponible en plusieurs couleurs.

**D**\_Abfallsammler für die Mülltrennung. Korpus und Boden bestehen aus epoxypulverlackiertem Stahl, zudem verfügen sie über einen entfernbaren Kunststoffdeckel in verschiedenen Farben.

**E**\_Cestos para la separación de residuos, el bidón y la base son de acero pintado con polvo epoxi y están dotados de una tapa removible de tecnopolímero, disponible en varios colores.



42 x 27 x h 70 / 85 cm



# CENTOLITRI

Caimi Lab

**I**\_Cestini ideati per la raccolta differenziata interamente realizzati in acciaio verniciato con polveri epossidiche, dotati di coperchio e reggisacchetto ribaltabili.

**EN**\_Bins projected for waste separation, entirely made in epoxy powder-coated steel, with folding lid and liner holder.

**F**\_Corbeilles pour le tri sélectif des déchets réalisées entièrement en acier peint en époxy, avec couvercle et support sac basculants.

**D**\_Abfallsammler, die für die Mülltrennung entworfen wurden, ganz aus pulverbeschichtetem Stahl, mit Klappdeckel und -Müllsackhalter.

**E**\_Cestos diseñados para recogida selectiva totalmente realizados en acero pintado con polvos epoxi, equipados con tapa y sujeta bolsas basculantes.



35 x 35 x h 85 cm



# MAXIMO

Caimi Lab

**I**\_Cestino ideato per la raccolta differenziata interamente realizzato in acciaio verniciato con polveri epossidiche, dotato di coperchi ribaltabili e reggisacchetto asportabile.

**EN**\_A bin, designed for separate waste collection made entirely of epoxy powder-coated steel, with hinged lids and a removable inner bucket.

**F**\_Corbeille conçue pour le tri sélectif des déchets, réalisée entièrement en acier peint en époxy, munie de couvercles rabattables et d'un porte-sacchet amovible.

**D**\_Ein idealer Behälter für Mülltrennung, gänzlich aus pulverbeschichtetem Stahl hergestellt, mit Klappdeckel und abnehmbarem Sackhalter.

**E**\_Contenedor concebido para la recogida selectiva de residuos realizado en acero pintado con polvos epoxi, equipado con tapa basculante y con soporte para bolsa extraíble.

62 x 35 x h 72 cm



**I**\_Grafiche adesive in tecnopolimero.

**EN**\_Adhesive graphics in technopolymer.

**F**\_Graphiques autocollantes en high-tech polymer.

**D**\_Kleber aus technischem Kunststoff mit Grafiken.

**E**\_Gráficas adhesivas de tecnopolímero.



# PRISMA

Sezgin Aksu, Silvia Suardi

**I**\_Innovativo ed elegante sistema di accessori contenitori, formato da portaombrelli per ombrelli a bastone o pieghevoli, posacenere, gettacarte e fioriere, realizzati interamente in acciaio inossidabile. Disponibili anche interamente realizzati in acciaio inossidabile AISI 304 adatti per l'utilizzo in esterno con fondo appositamente forato per far defluire l'acqua piovana e predisposizione per il fissaggio a terra.

**EN**\_Innovative and elegant line of containers, consisting of umbrella stands for long or foldable umbrellas, ashtrays, waste bins and planters, all made entirely of stainless steel. Also available made entirely of AISI 304 stainless steel, suitable for external use, equipped with perforated base for the drainage of rainwater, especially designed for being fixed to the ground.

**F**\_Système innovant et élégant d'accessoires-bacs, constitué de porte-parapluies, pour parapluies normaux et pliables, cendriers, corbeilles à papier et jardinières, entièrement réalisés en acier inoxydable. Disponibles aussi entièrement en acier inoxydable AISI 304 prévus pour l'utilisation à l'extérieur avec base forée pour faire couler l'eau de pluie et prévue pour la fixation au sol.

**D**\_Innovatives und elegantes Behältersystem aus einem Schirmständer für Lang- und Taschenschirme, Aschenbecher, Papierkorb und Blumenkübel, komplett aus rostfreiem Stahl. Auch vollständig aus rostfreiem Stahl AISI 304 für die Verwendung in Außenbereichen mit speziell gelochtem Boden für den Abfluss des Regenwassers und Möglichkeit zur Bodenbefestigung erhältlich.

**E**\_Un innovador y elegante sistema de accesorios contenedores formado por paragüeros para paraguas clásicos como para los plegables, ceniceros, papeleras y macetas. Disponible también completamente de acero inoxidable AISI 304 aptos para su uso en exterior con un fondo perforado para dejar que pase el agua de lluvia. Puede fijarse al suelo.

34 x 35 x h 35 / 50 / 70 cm





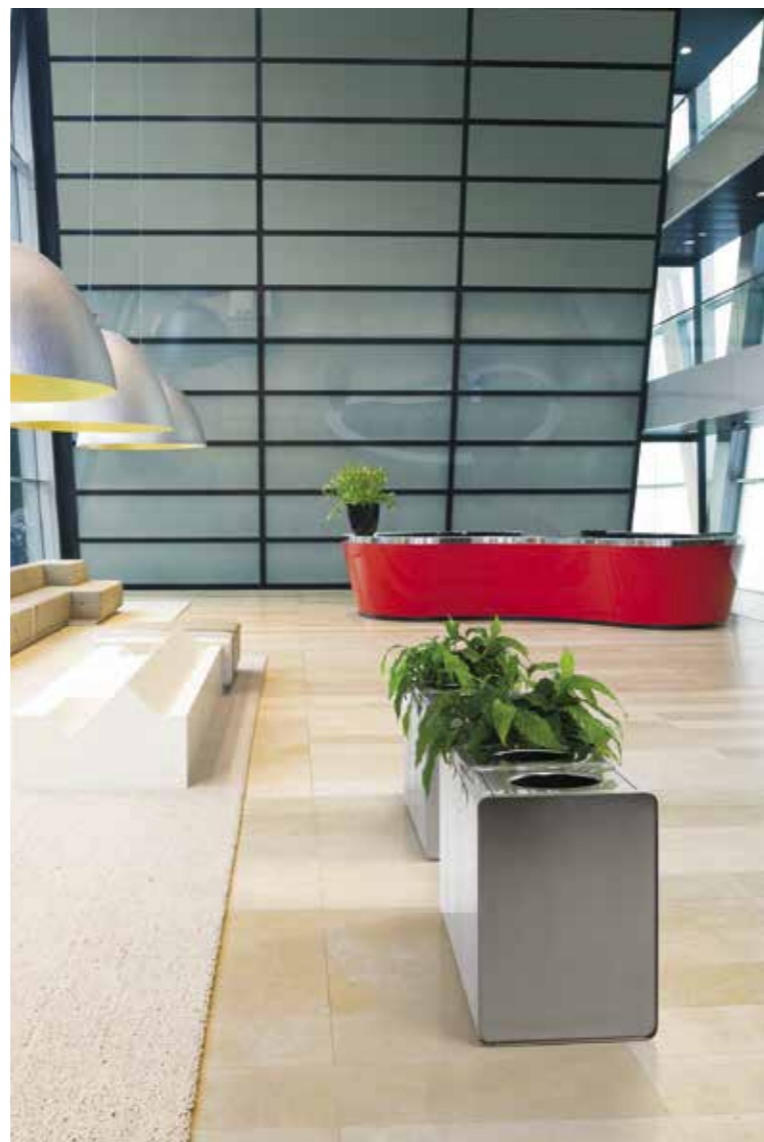

# SMILE

Caimi Lab

**I**\_Cestino gettacarte da parete utilizzabile anche per esterni, realizzato in acciaio inossidabile AISI 304 con fondo forato per fare defluire l'acqua piovana, dotato di serratura di sicurezza.

**EN**\_Wall-mounted waste-paper basket also for outdoor use, made of AISI 304 stainless steel with perforated bottom for the outflow of rainwater. Equipped with safety lock.

**F**\_Corbeille à papier murale utilisable aussi à l'extérieur, réalisée en acier inoxydable AISI 304, avec fond perforé pour l'écoulement de l'eau de pluie et pourvue de serrure de sûreté.

**D**\_Papierkorb für Wandmontage aus rostfreiem Stahl AISI 304, auch für Aussenanwendung geeignet, mit gelochtem Boden, damit das Regenwasser durchfließen kann, mit Sicherheitsschloss ausgestattet.

**E**\_Papelera a pared para exterior, realizada en acero inoxidable AISI 304 con fondo perforado para evacuar el agua de lluvia. Equipado con cerradura de seguridad.

25 x 13 x h 35 cm



# TORRE

Caimi Lab

**I**\_Linea di posacenere-gettacarte utilizzabili anche per esterni, realizzati interamente in acciaio inossidabile AISI 304, dotati di fermasacchetto e di vaschetta posacenere interna estraibili per facilitare le operazioni di pulizia. Il coperchio è dotato di un sistema di bloccaggio con serratura. Fondo appositamente forato per fare defluire l'acqua piovana. La base è predisposta per il fissaggio a terra.

**EN**\_Line of ashtrays/waste bins suitable for external use, made entirely of AISI 304 stainless steel, equipped with bag holder and extractable internal ashtray for easy cleaning. The cover is equipped with a locking system. Perforated base for the drainage of rainwater, especially designed for being fixed to the ground.

**F**\_Ligne de cendriers-corbeilles à papier utilisables à l'extérieur, réalisés complètement en acier inoxydable AISI 304, avec support de sac et bac cendrier interne extractibles pour faciliter les opérations de nettoyage. Le couvercle est doté d'un système de blocage avec serrure. Fond foré pour faire couler l'eau de pluie. La base est prévue pour la fixation au sol.

**D**\_Serie an Aschenbechern-Papierkörben, die auch in Außenbereichen verwendet werden können. Komplett aus rostfreiem Stahl AISI 304, mit Müllsackbehälter und interner, ausziehbarer Aschenschublade für eine vereinfachte Reinigung. Der Deckel verfügt über ein Absperrsystem mit Schloss. Speziell gelochter Boden für den Abfluss des Regenwassers. Die Basis kann am Boden befestigt werden.

**E**\_Línea de cenicero-papelera, aptos también para exterior, completamente de acero inoxidable AISI 304, dotados de sujeción bolsa y cubeta cenicero extraíbles para facilitar las operaciones de limpieza. La tapa está dotada de un sistema de bloqueo con cerradura. Fondo perforado para dejar que pase el agua de lluvia. La base puede fijarse al suelo.

36 x 34 x h 80,5 cm



# EXTERNO

Angelotti & Cardile

**I**\_Posacenere per esterni con fusto in alluminio verniciato con polveri epossidiche. Base in acciaio zincato e verniciato.

**EN**\_Outdoor ashtray with drum in powder-coated aluminum. Base in zinc-coated, painted steel.

**F**\_Cendrier pour extérieur avec fût en aluminium peint époxy. Base en acier zingué et peint.

**D**\_Aschenbecher für draußen mit Standsäule aus mit Epoxidpulver beschichtetem Aluminium, Basis aus verzinktem und beschichtetem Stahl.

**E**\_Ceniceros para exterior con columna de aluminio pintado con polvo epoxi. Base de acero zincado y pintado.

ø 32 x h 100 cm

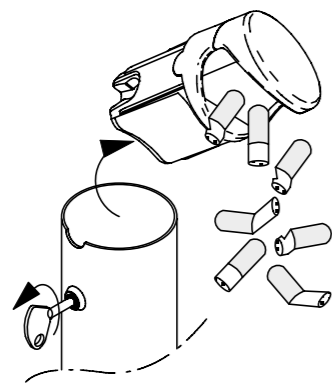

# PIAZZA

Caimi Lab

**I**\_Posacenere da parete utilizzabile anche per esterni, realizzato in acciaio inossidabile AISI 304 con vaschetta interna raccogli cenere estraibile, dotato di serratura di sicurezza.

**EN**\_Wall-mounted ashtray also for outdoor use, made from AISI 304 stainless steel, with internal extractable ash box, with safety lock.

**F**\_Cendrier mural utilisable aussi à l'extérieur, réalisé en acier inoxydable AISI 304 avec bac récepteur interne extractible pour les cendres et équipé d'une serrure de sécurité.

**D**\_Wand-Aschenbecher, kann auch in Außenbereichen verwendet werden, hergestellt aus rostfreiem Stahl AISI 304 mit herausnehmbarem Aschenbehälter, versehen mit Sicherheitsverschluss.

**E**\_Cenicero de pared utilizable también para exterior, realizado en acero inoxidable AISI 304 con recipiente interior de recogida de cenizas extraíble, dotado de cerradura de seguridad.

15 x 8 x h 26 cm





## OREDODICI

Caimi Lab

**I**\_Orologio da parete in tecnopolimero laccato.

**EN**\_Wall-mounted clock in enamelled high-tech polymer.

**F**\_Horloge mural en technopolymère laqué.

**D**\_Wanduhr aus lackiertem Technopolymer.

**E**\_Reloj de pared de tecnopolímero lacado.



ø 40 cm



# BISS

Giulio Iacchetti

**I**\_Passacavi modulare in tecnopolimero con staffa di aggancio utilizzabile sia sotto al piano della scrivania sia sul fianco e peso terminale completamente arrotondato.

**EN**\_Modular high-tech polymer cable sleeve with bracket to fasten under the top or on the side of the desk and a round weight to improve stability.

**F**\_Passe-câbles modulaire en technopolymère avec tige d'accrochage utilisable au-dessous du bureau ou sur le côté, ballast terminal complètement arrondi.

**D**\_Modularer Kabelkanal aus Technopolymer mit Befestigungsleiste, die sowohl unter der Schreibtischplatte als auch seitlich verwendet werden kann, mit beschwertem und abgerundetem Ende.

**E**\_Canaletas pasacables expansible en tecnopolimero con brida de sujeción aplicable bajo la parte inferior del plano del escritorio o en su parte lateral. El peso terminal está completamente redondeado.

\_\_\_\_\_

L max 79 cm

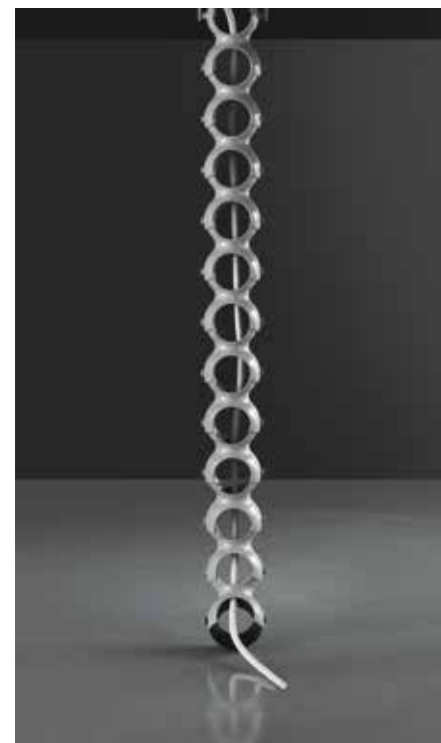

# UP

Caimi Lab

**I**\_Ripiano porta-monitor da appoggio su piano della scrivania realizzato in acciaio verniciato con polveri epossidiche.

**EN**\_Monitor shelf to be placed on the desk, carried out in powder-coated steel.

**F**\_Tablette porte-écran à poser sur le plan du bureau, réalisée en acier peint en époxy.

**D**\_Monitorträger aus pulverbeschichtetem Stahl zur Aufstellung auf dem Schreibtisch.

**E**\_Estante para pantallas à posicionar sobre plano de trabajo, realizado de acero pintado epoxi.

\_\_\_\_\_

33 x 22 h 10 cm



# BELT

Caimi Lab

**I**\_Porta-CPU costituito da quattro angolari in tecnopolimero colore grigio e da due cinghie facilmente regolabili.

**EN**\_CPU-cradle in grey high-tech polymer provided with two easily adjustable belts.

**F**\_Porte unité centrale formé de quatre cornières en technopolymère gris et deux courroies facilement réglables.

**D**\_CPU-Halterung aus grauem Technopolymer. Die vier Kunststoffwinkel geben dem CPU sicheren Halt. Einfach zu befestigen.

**E**\_Soporte para ordenador constituido por cuatro angulares en tecnopolímero en color gris por dos correas fácilmente regulables.



# HI-TECH

Caimi Lab

**I**\_Sottomano in espanso nero.

**EN**\_Desk pad in black plastic foam.

**F**\_Sous-main en expansé noir.

**D**\_Schreibunterlage aus schwarzem Kunststoff.

**E**\_Carpeta en material expandido negro.

\_\_\_\_\_

50 x 35 cm



# DESK-UP

Acropoli, Caimi Lab

**I**\_Accessori per scrivania e sospesi in tecnopolimero o policarbonato. Profili a parete in alluminio anodizzato.

**EN**\_Desk or suspended accessories in high-tech polymer or polycarbonate. Wall toolbars in anodized aluminum.

**F**\_Accessoires de bureau ou suspendus en technopolymère ou polycarbonate. Profils murales en aluminium anodisé.

**D**\_Schreibtischzubehör zum Aufstellen bzw. Einhängen aus Technopolymer oder Polycarbonat. Wandprofile aus eloxiertem Aluminium.

**E**\_Accesorios para escritorio y suspendidos de tecnopolímero o policarbonato. Perfiles a pared de aluminio anodizado.



# PLAT

Alessandro Zambelli

**I** Originale oggetto polifunzionale realizzato in gres colorato: ogni singolo pezzo è ottenuto con una particolare lavorazione manuale di colatura. Utilizzabile come portaoggetti o portapenne.

**EN** An original looking multifunctional object made of colored stoneware: each single piece is specially cast by hand. It can be used as a recipient for miscellaneous items or as a pen holder.

**F** Objet original multifonctions réalisé en grès coloré : chaque pièce est obtenue avec un moulage particulier fait à la main. A utiliser comme porte-objet ou porte-stylo.

**D** Originelles Mehrzweckobjekt aus farbigem Steingut. Jedes Einzelstück wird in einem besonderen manuellen Gießverfahren hergestellt. Kann als Ablage für Material oder Kugelschreiber verwendet werden.

**E** Objeto original multifuncional de gres de colores: cada pieza está hecha a mano con un proceso especial de encolado. Se puede usar como portaobjetos o portalápices.

34 x 22 x h 7 cm



# KABO

Alessandro Zambelli

**I** Originale oggetto polifunzionale realizzato in gres colorato: ogni singolo pezzo è ottenuto con una particolare lavorazione manuale di colatura. Utilizzabile come portafiori, portaoggetti, portapenne, portaombrelli o, semplicemente, grazie alle forme sinuose, come oggetto decorativo d'arredo.

**EN** An original looking multifunctional object made of coloured stoneware: each single piece is specially cast by hand. It can be used as a vase, as a recipient for miscellaneous items, as a pen holder, as an umbrella stand or, simply as a decorative piece of sinuously elegant furniture.

**F** Objet original multifonctions réalisé en grès coloré: chaque pièce est obtenue avec un moulage particulier fait à la main. A utiliser comme porte-fleurs, porte-objets, porte-stylo, porte-parapluies ou, simplement à cause de ses formes sinueuses, comme objet de décoration d'intérieur.

**D** Originelles Mehrzweckobjekt aus farbigem Steingut: Jedes Einzelstück wird in einem besonderen manuellen Gießverfahren hergestellt. Kann als Blumentopf, Ablage für Material oder Kugelschreiber, Schirmablage oder einfach, dank seiner anmutigen Form, als dekoratives Einrichtungselement verwendet werden.

**E** Objeto original multifuncional de gres de colores: cada pieza está ensamblada a mano con un proceso especial de encolado. Se puede usar como maceta, portaobjetos, portalápices, paraguero o, simplemente, gracias a su forma sinuosa, como objeto decorativo.

46 x 32 x h 15 cm











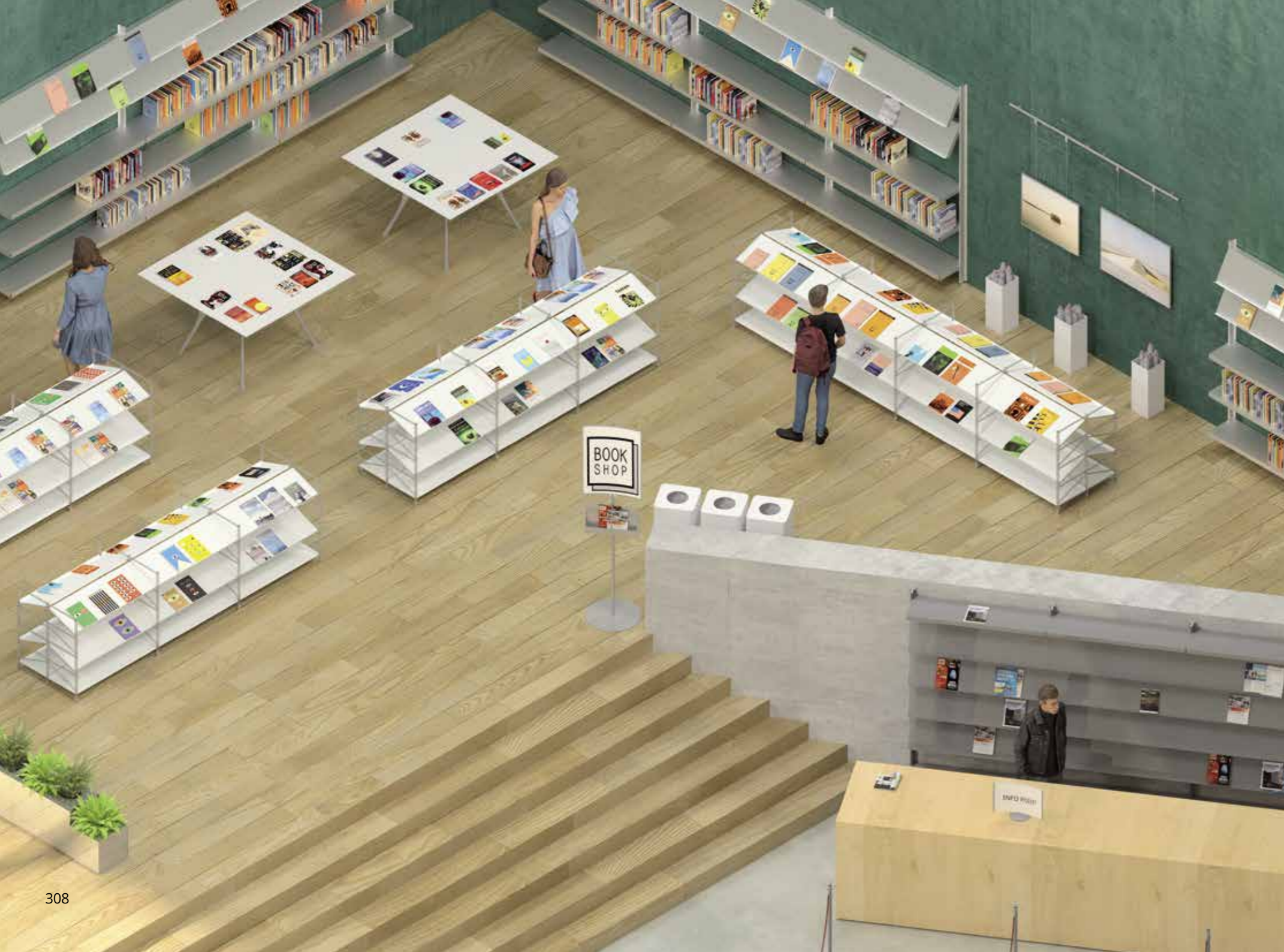





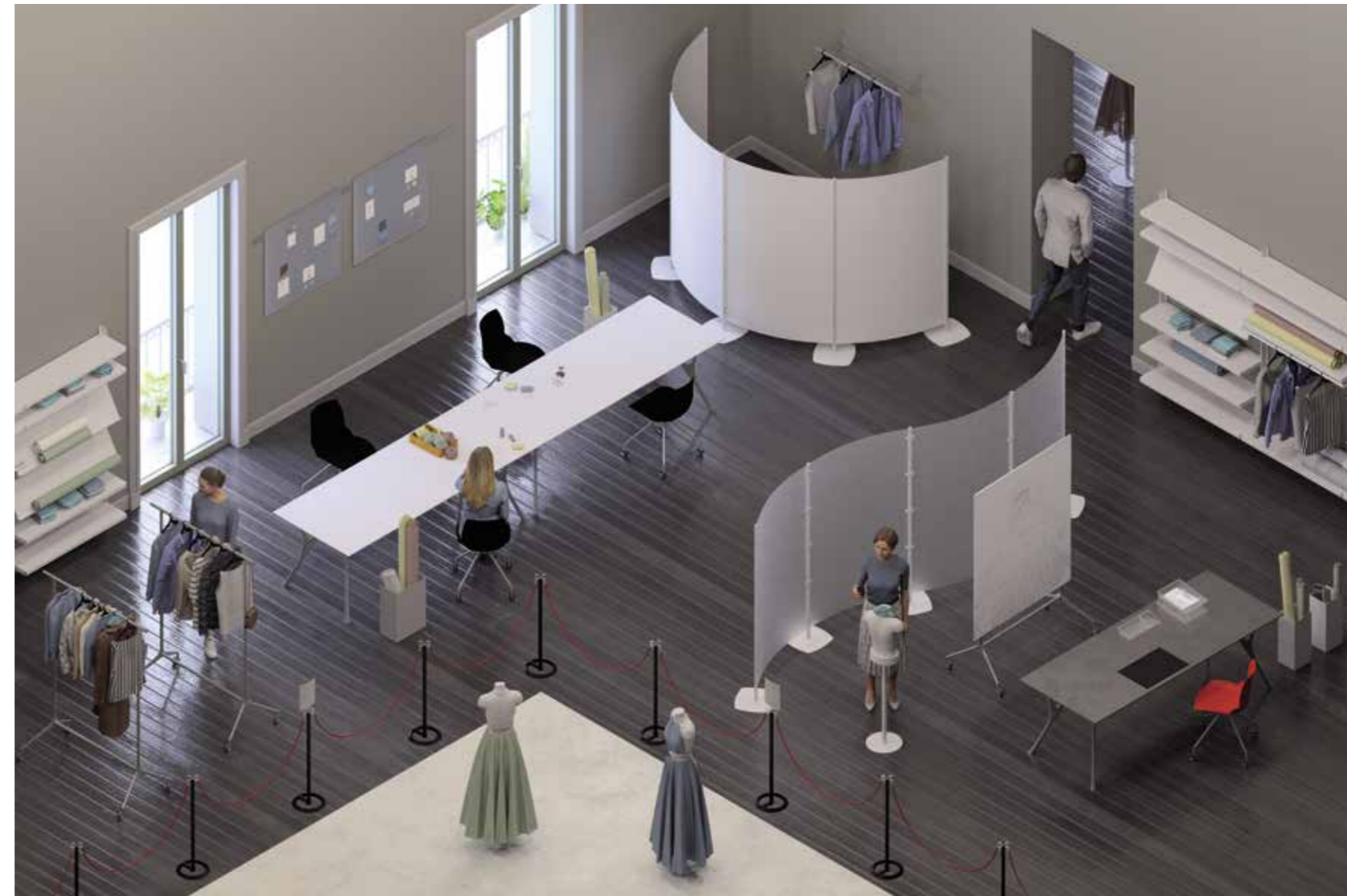





# CAIMI BREVETTI since 1949

**I**\_Fondata nel 1949, Caimi è una delle principali realtà produttive europee design oriented nel settore dell'arredamento, dei complementi d'arredo e delle soluzioni acustiche per l'ufficio, la casa e il contract. Da **oltre 70 anni** Caimi continua a ricercare e sperimentare nuove soluzioni per migliorare concretamente la vita delle persone e gli ambienti in cui vivono. Grazie ad una sofisticata integrazione fra struttura produttiva e logistica, gestisce con successo una gamma di prodotti composta da oltre **3.000** articoli e **35.000** componenti, garantendo alla propria clientela tempi di consegna estremamente rapidi.

**EN**\_Founded in 1949, Caimi is one of the leading European design-oriented manufacturers of furniture and complements for the office, home and contract sectors. For **over 70 years** Caimi has continued to research and assay new solutions for the betterment of people's lives and living spaces. Thanks to its sophisticated integration of production line work and logistics operations, Caimi can effect extremely fast deliveries of any orders from its product range, which is made up of around **3.000** items and more than **35.000** separate components.

**F**\_Fondée en 1949, Caimi est l'une des principales entreprises européennes de production axée sur le design, dans le domaine de l'ameublement, des accessoires de décoration et des solutions acoustiques pour le bureau, la maison et les grands projets clé en main. Depuis **plus de 70 années**, Caimi est à la recherche de nouvelles solutions pour améliorer de manière concrète la vie des personnes et de leur habitat. Grâce à une intégration sophistiquée entre sa structure de production et la logistique, Caimi peut gérer avec succès une gamme d'environ **3.000** produits avec plus de **35.000** composants, assurant ainsi des délais de livraison extrêmement rapides à ses clients.

**D**\_1949 gegründet, ist Caimi eines der führenden Design-orientierten Hersteller in Europa in der Branche Einrichtung, Einrichtungszubehör und Schalldämpflösungen für Büro, Wohnen und Contract. Seit **über 70 Jahren** erforscht und experimentiert Caimi neue Lösungen, um das Leben der Menschen und die Räume, in denen sie leben, zu verbessern. Dank der hochentwickelten Integration zwischen Produktion und Logistik kann Caimi eine breite Palette an Produkten erfolgreich herstellen und vertreiben, die über **3.000** Produkte und **35.000** Komponenten miteinschließt, und somit den eigenen Kunden extrem schnelle Lieferzeiten garantieren.

**E**\_Fundada en 1949, Caimi es una de las principales empresas productoras europeas dedicada al diseño en el sector del interiorismo, de los complementos decorativos y de las soluciones acústicas para oficina, hogar y contract. Desde hace **más de 70 años** Caimi sigue investigando y desarrollando novedosas soluciones para mejorar la vida de las personas y el entorno en el que viven. Gracias a una integración avanzada entre estructura de producción y logística, gestiona exitosamente una gama de productos que consta de más de **3.000** artículos y **35.000** componentes, garantizando a sus clientes plazos de entrega sumamente rápidos.

An always evolving company with 3 main divisions

**INTERIORS**  
**Caimi**

Office, Home & Contract Solutions

**SNOWSOUND**  
**Caimi**

Acoustic Products & Textiles

**OPEN LAB**  
**Caimi**

Research, Academy & No Profit



# SNOWSOUND acoustic products & textiles

**I** Con la divisione Snowsound, Caimi ha indirizzato le proprie ricerche scientifiche e tecnologiche finalizzandole al benessere acustico delle persone, ideando e brevettando soluzioni e prodotti fonoassorbenti. Con oltre 40 premi internazionali Snowsound è diventata un punto di riferimento a livello internazionale nel mondo dell'acustica.

**EN** Caimi's Snowsound division is dedicated to the scientific and technological research that the company has carried out in the name of bringing acoustic comfort to the world by designing and patenting sound-absorbing solutions and products. Winner of 40 international awards, Snowsound is a landmark in the world of acoustics.

**F** Avec la division Snowsound, Caimi a orienté ses recherches scientifiques et technologiques vers le confort acoustique des personnes, en concevant et en brevetant des solutions et des produits anti-bruit. Ayant à son actif plus de 40 prix internationaux, Snowsound est devenu une référence internationale de l'acoustique.

**D** Mit der Snowsound-Abteilung hat Caimi die eigene wissenschaftliche Forschung auf das Thema des akustischen Wohlbefindens der Menschen fokussiert, indem es schalldämpfende Lösungen und Produkte entworfen und zum Patent angemeldet hat. Mit über 40 internationalen Auszeichnungen ist Snowsound zu einem internationalen Referenzbegriff in der Welt der Akustik avanciert.

**E** En el Departamento Snowsound, Caimi ha centrado sus investigaciones científicas y tecnológicas en el bienestar acústico de las personas, diseñando y patentando soluciones y productos fonoabsorbentes. Con más de 40 premios internacionales Snowsound ya es un referente a nivel internacional en el ámbito de la acústica.

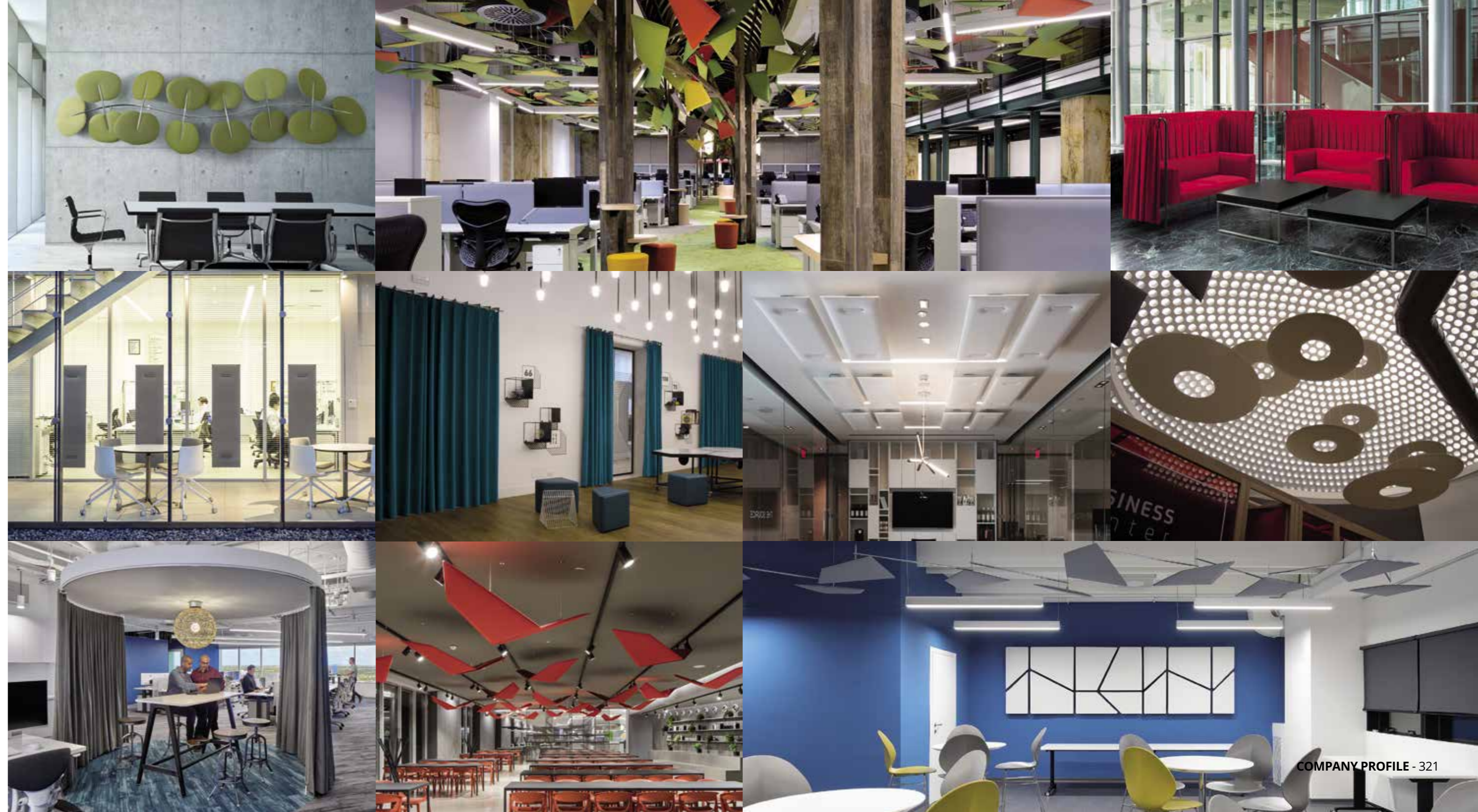

## OPEN LAB research, academy & no profit

**I** Open Lab è uno spazio all'avanguardia che vanta 7 laboratori avveniristici dedicati alla ricerca teorica e applicata in ambito tecnologico, acustico e fisico. Un centro di ricerca volto a sperimentare il comportamento del suono, le capacità percettive dell'uomo e gli effetti che il suono ha sull'essere umano. In linea con le tradizioni della nostra azienda da sempre sensibile ai problemi sociali e con l'obiettivo di trovare soluzioni che contribuiscano a rendere migliore la qualità della vita, Open Lab è anche una struttura no profit gratuitamente messa al servizio di Università, Istituti di Ricerca, Fondazioni ed Enti. Open Lab, un grande laboratorio aperto al mondo, perché non esiste innovazione senza ricerca.

**EN** Open Lab is an advanced facility housing seven futuristic laboratories dedicated to theoretical and applied research in technology, acoustics and physics. The purpose of the research facility is to carry out experiments on the behaviour of sound, on the perceptive capacities of humans, and on the effects of sound on people. In keeping with the traditions of our company, which has always been socially aware and has always aspired to solutions that improve the quality of life of all, Open Lab operates as a not-for-profit entity that is placed free of charge at the disposition of universities, research institutes, foundations and public-sector bodies. Open Lab: A laboratory complex whose doors are open to the world; without research, there can be no innovation.

**F** Open Lab est un lieu à l'avant-garde qui vante 7 laboratoires ultra-modernes dédiés à la recherche théorique et appliquée dans le domaine technologique, acoustique et physique. Un centre de recherche pour expérimenter le comportement du son, la capacité perceptive et les effets du son sur les êtres humains. En ligne avec les traditions de notre entreprise, depuis toujours sensible aux problèmes sociaux et à la recherche de solutions qui contribueront à améliorer la qualité de vie, Open Lab est en même temps une structure sans but lucratif au service des universités, instituts de recherche, fondations et autres organismes. Open Lab, un grand laboratoire ouvert au monde, car l'innovation ne peut exister sans la recherche.

**D** Open Lab ist ein Experimentierraum mit 7 zukunftsweisenden Labors, die sich mit theoretischer Forschung und ihrer Anwendung auf Technologie, Akustik und Physik befassen. Ziel des Forschungszentrums ist die Auslotung von Schallverhalten und menschlicher Wahrnehmung sowie der Auswirkungen von Schall auf den Menschen. Im Einklang mit der Tradition eines Unternehmens, das schon immer empfänglich war für soziale Themen und mit dem Ziel, Lösungen zu entwickeln, die zur Besserung der Lebensqualität beitragen, gestaltet sich Open Lab gleichzeitig als gemeinnützige Struktur, die kostenlos im Dienst von Universitäten, Forschungsinstituten, Stiftungen und Einrichtungen arbeitet. Open Lab ist ein großes, der Welt offenes Labor, weil es ohne Forschung keine Innovation gibt.

**E** Open Lab es un espacio vanguardista que cuenta con 7 laboratorios punteros orientados a la investigación teórica y aplicada en el ámbito tecnológico, acústico y físico. Un centro de investigación que permite experimentar el comportamiento del sonido, la capacidad de percepción del ser humano y los efectos que el sonido ejerce sobre este. De acuerdo con la tradición de nuestra empresa, siempre atenta a los problemas sociales. y con el objetivo de encontrar soluciones que logren aportar mejoras a la calidad de vida, Open Lab es también una estructura sin ánimo de lucro que se pone al servicio de Universidades, Institutos de Investigación, Fundaciones y Entidades. Open Lab, es un gran laboratorio abierto al mundo, porque no existe innovación sin investigación.

**OPEN LAB**  
Caimi



SUPERNOVA LAB, semi-anechoic chamber

## PATENTS

**I**\_Da oltre 70 anni, Caimi ritiene fondamentale la scelta di tutelare attraverso il brevetto le proprie invenzioni ed il proprio lavoro. Sono centinaia i prodotti dell'azienda coperti da brevetti e modelli, garanzia dell'attenzione prestata all'utilità e originalità dei prodotti proposti. Il costante impegno ha visto Caimi vincitrice della prima edizione del "DesignEuropa Awards", organizzato dall'Ufficio dell'Unione Europea per la Proprietà Intellettuale (EUIPO) a conferma della sua vocazione alla ricerca e alla tutela dell'invenzione, il vero capitale di Caimi.

**EN**\_During its 70 years of existence, Caimi's policy has been to protect its future by patenting its inventions and products. Hundreds of its products are therefore covered by patents and utility models that attest both their usefulness and their originality. In recognition of its unstinting commitment to research and patent protection, which is where the real capital wealth of the company lies, Caimi was declared winner of the first edition of the "DesignEuropa Awards" organized by the European Union Intellectual Property Office (EUIPO).

**F**\_Depuis plus de 70 ans, Caimi a choisi de protéger ses inventions et son travail par des brevets. Des centaines de produits de notre entreprise sont couverts par des brevets et des modèles, témoignant l'attention que nous avons accordée à l'utilité et à l'originalité des produits proposés. Grâce à son engagement constant, Caimi a été lauréat de la première édition du Prix "DesignEuropa Awards", organisé par l'Office de l'Union européenne pour la propriété intellectuelle (EUIPO). Un prix qui confirme la vocation pour la recherche et la protection de l'invention, véritable capital de Caimi.

**D**\_Seit über 70 Jahren sieht Caimi die Entscheidung als grundlegend an, die eigenen Erfindungen und die eigene Arbeit durch Patente zu schützen. Das Unternehmen zählt Hunderte von durch Patente und Modelle geschützten Produkten, die für die Aufmerksamkeit einstehen, die der Nützlichkeit und Originalität der angebotenen Produkte geschenkt wird. Dank unnachgiebigem Einsatz gewann Caimi die erste Auflage des vom Europäischen Büro für geistiges Eigentum (EUIPO) ausgeschriebenen "DesignEuropa Awards" - eine Bestätigung seiner Berufung zu Forschung und Erfindungsschutz, welche das wahre Kapital von Caimi bilden.

**E**\_Desde hace más de 70 años, Caimi considera fundamental la decisión de salvaguardar sus inventos y su trabajo a través de sus patentes. La empresa posee centenares de productos cubiertos por patentes y modelos, una garantía de la atención que se presta a la utilidad y originalidad de los productos presentados. Caimi, por su constante dedicación e innovación, fue galardonada con el "DesignEuropa Award" en su primera edición, otorgado por la Oficina de la Unión Europea para la Propiedad Intelectual (EUIPO). Esto no hace más que confirmar el compromiso de la compañía por la investigación y la protección de la innovación, el verdadero capital de Caimi.



## MADE IN ITALY

**I**\_Sin dalla sua fondazione, nel 1949, Caimi associa alla precisione della produzione industriale la cura dei dettagli e delle finiture tipica della migliore produzione artigianale italiana. Caimi ha un approccio innovativo al lavoro, una filosofia che unisce la qualità handmade alla perfezione di un'azienda moderna e tecnologicamente avanzata.

**I nostri prodotti sono progettati e fabbricati in Italia.**

**EN**\_Since its foundation in 1949, Caimi has combined precision industrial manufacturing with the close attention to fine detail and finishes that is a hallmark of Italian craft excellence. Caimi pursues an innovative strategy inspired by a philosophy that combines the handmade quality of a craft worker with the manufacturing perfection of a technologically advanced company. **Our products are designed and manufactured in Italy.**

**F**\_Depuis sa fondation en 1949, Caimi associe à la précision de la production industrielle, l'amour pour les détails et les finitions typiques de la meilleure production artisanale italienne. Caimi a adopté une approche innovante du travail, une philosophie qui unit la qualité de l'artisanat avec la perfection d'une entreprise moderne et technologiquement avancée. **Nos produits sont conçus, développés et fabriqués en Italie.**

**D**\_Seit seiner Gründung 1949 verbindet Caimi die Präzision der industriellen Herstellung mit dem Gefühl für Detail und Ausführung, die die beste italienische Handwerkstradition auszeichnet. Caimi hat einen innovativen Ansatz, seine Philosophie bringt die Qualität des Handgemachten mit der Makellosigkeit einer modernen, technologisch fortgeschrittenen Herstellung zusammen. **Unsere Produkte sind in Italien entworfen und hergestellt.**

**E**\_Desde su fundación en 1949, Caimi compagina la precisión con la producción industrial, la atención por el detalle y con el diseño característico de la mejor producción artesanal italiana. Caimi tiene un enfoque innovador del trabajo, una filosofía que fusiona la calidad de lo hecho a mano con la perfección de una empresa moderna y tecnológicamente avanzada. **Todos nuestros productos se diseñan y fabrican en Italia.**



## ECOLOGY

**I**\_Caimi Brevetti, da sempre sensibile nei confronti delle tematiche ambientali e dell'ecosostenibilità, utilizza, dove tecnicamente possibile, materiali riciclabili o riutilizzabili. La produzione è composta in prevalenza da oggetti monomaterici, facilmente riciclabili: gli oggetti composti da più materiali sono in larga parte pensati per essere disassemblabili, consentendo di riciclare separatamente i singoli componenti. Il 90% della merce prodotta dalla nostra azienda viene lavorata nel raggio di 30 km dalla nostra sede centrale, dove è situato il nostro centro logistico: questo ci permette di ridurre sensibilmente la strada percorsa dai mezzi di trasporto, riducendo il consumo di carburanti.

**EN**\_Caimi Brevetti has always had an attentive eye for environmental issues and eco-sustainability. This is why, if technically feasible, we use recyclable or reusable materials. Production consists mainly of single-material, easily recyclable objects: objects made of multiple materials are in most cases designed to be disassembled. This allows separate recycling of the individual components. Approximately 90% of Caimi products are processed within a 30 km radius from our central plant, where our logistics centre is located. This set up significantly reduces product transportation travel, thereby decreasing fuel consumption of the vehicles.

**F**\_Caimi Brevetti, depuis toujours sensible aux thématiques de l'environnement et de l'éco-durabilité, utilise, quand c'est techniquement possible, des matériaux recyclables ou réutilisables. La production est composée surtout d'objets monomatériaux, facilement recyclables, et les objets composés de plusieurs matériaux sont généralement pensés pour être désassemblés, ce qui permet donc de recycler séparément chaque composant. 90% des marchandises produites par notre entreprise sont fabriquées dans un rayon de 30 km de notre siège central, où se trouve notre centre logistique: ceci nous permet de réduire sensiblement le chemin parcouru par les moyens de transport, en réduisant la consommation de carburant.

**D**\_Caimi Brevetti ist seit jeher mit Umweltthemen und der Umweltverträglichkeit vertraut und verwendet, wo technisch möglich, wiederverwertbare oder recyclebare Materialien. Die Produktion besteht überwiegend aus Monomaterial- Gegenständen, die leicht recyclebar sind: die Gegenstände aus mehreren Materialien sind zum Großteil so entwickelt, dass sie auseinander gebaut werden können, wodurch das Recycling der einzelnen Komponenten ermöglicht wird. 90% der von unserem Unternehmen produzierten Ware wird im Umkreis von 30 km von unserem Hauptsitz, wo sich unser Logistikzentrum befindet, verarbeitet: Dies ermöglicht es uns, die von den Transportmitteln zurückgelegten Strecken und damit den Kraftstoffverbrauch deutlich zu verringern.

**E**\_Caimi Brevetti, desde siempre sensible con los temas medioambientales y la ecosostenibilidad, utiliza siempre que sea técnicamente posible materiales reciclables o reutilizables. La producción está compuesta en su mayoría por objetos monomatericos, fácilmente reciclables: los objetos compuestos por varios materiales están en su mayoría pensados para desensamblarlos, permitiendo reciclar por separado cada componente. El 90% de la mercancía que produce nuestra empresa se elabora en un radio de 30 km de nuestra sede central, que es donde se sitúa nuestro centro logístico: esto nos permite reducir de forma sensible el trayecto que recorren los medios de transporte, reduciendo por consiguiente el consumo de carburantes.

## AWARDS

**I** Presente nei musei di design internazionali, Caimi ha ricevuto decine di riconoscimenti e premi in tutto il mondo, tra i quali due Compassi d'Oro, tre German Design Award, e quattordici ADI design Index. L'elenco completo dei premi è disponibile sul sito [www.caimi.com](http://www.caimi.com)

**EN** With its products displayed in design museums around the world, Caimi has received dozens of international awards and prizes, including two Compasso d'Oro prizes, three German Design Award, and fourteen ADI Design Index prizes. The full list of prizes and awards is available at [www.caimi.com](http://www.caimi.com)

**F** Présente dans les musées internationaux de design, Caimi a reçu des dizaines de prix et récompenses dans le monde entier, dont deux Compasso d'Oro, trois German Design Award et quatorze ADI design Index. La liste complète des prix est disponible sur notre site [www.caimi.com](http://www.caimi.com)

**D** In den internationale Design-Museen ausgestellt, wurde Caimi mit zahlreichen Preisen und Auszeichnungen in der ganzen Welt bedacht, darunter zwei Compasso d'Oro, drei German Design Award und vierzehn ADI Design Index. Die vollständige Liste der Preise und Auszeichnungen kann auf der Webseite [www.caimi.com](http://www.caimi.com) konsultiert werden.

**E** Con obras expuestas en museos de diseño a nivel internacional, Caimi ha recibido decenas de reconocimientos y premios en todo el mundo, entre ellos dos Compasso d'Oro, tres German Design Awards y catorce ADI design Index. La lista completa de premios se puede encontrar en la página web [www.caimi.com](http://www.caimi.com)

Over **60** international awards



COMPASSO D'ORO



GERMAN  
DESIGN  
AWARD  
WINNER



## DESIGNERS

Acropoli

Sezgin Aksu

Alessandro Angelotti

Archistudio

Pietro Arosio

Felicia Arvid

Claudio Bellini

Mario Bellini

Chiara Bevegni

Claus Breinholt

Caimi Lab

Letterio Cardile

Aldo Cibic

Marco Cocco

Massimo Colagrande

Lorenzo Damiani

Paul De Feiter

Michele De Lucchi

Annalisa Dominoni

Gillo Dorfles

Frida Doveil

Giancarlo Fassina

Moreno Ferrari

Carlo Forcolini

Graziano Friscione

Ton Haas

Giulio Iacchetti

Id Vision

Perry King

M+A+P Design Studio

Raffaello Manzoni

Alberto Meda

Francesco Meda

Alessandro Mendini

Francesco Mendini

Gianni Menguzzato

Santiago Miranda

Claudio Nascimben

Philippe Nigro

Lorenzo Palmeri

Eleonore Peduzzi Riva

Pierandrei Associati

Benedetto Quaquaro

Francesco Radaelli

Matteo Ragni

Marc Sadler

Lorenzo Stano

Silvia Suardi

Mario Trimarchi

Alessandro Zambelli

**I\_Caimi Brevetti S.p.A.** si riserva, a proprio insindacabile giudizio, la facoltà di modificare senza preavviso i materiali costruttivi, le caratteristiche tecniche ed estetiche, nonché le dimensioni degli elementi illustrati nel presente catalogo le cui immagini e colori sono puramente indicativi. Il testo facente fede è esclusivamente quello in lingua italiana, le traduzioni hanno la finalità esclusiva di semplificarne la lettura. Prima di procedere all'acquisto dei prodotti illustrati nel presente catalogo consultate le condizioni di vendita nonché le caratteristiche tecniche e le avvertenze riportate nel listino prezzi in vigore.

**EN\_Caimi Brevetti S.p.A.** reserves, by its unappealable judgment, the right to modify without prior notice the building materials, the technical and aesthetic specifications, as well as the dimensions of the products in this catalogue, where pictures and colours are purely as an indication. The authentic text is only in Italian, the translation has the mere purpose of simplifying the reading. Prior to purchasing the products in this catalogue please consult the sale conditions and also the technical specifications and warnings in the current price list.

**F\_Caimi Brevetti S.p.A.** se réserve, à son jugement sans appel, la faculté de modifier sans aucun préavis les matériaux de construction, les caractéristiques techniques et esthétiques ainsi que les dimensions des éléments illustrés dans ce catalogue, dont les images et couleurs sont seulement indicatifs. Le text de référence est seulement celui en italien, les traductions ont le seul but de simplifier la lecture. Avant de procéder à l'achat des produits illustrés dans ce catalogue, consulter les conditions de vente, les caractéristiques techniques et les mises en garde reportées dans le tarif en vigueur.

**D\_Caimi Brevetti S.p.A.** behält sich das Recht vor, ihrer unanfechtbaren Entscheidung nach, verwendete Materialien, technische und ästhetische Details sowie die Abmessungen der in diesem Katalog abgebildeten Produkte ohne vorherige Ankündigung zu ändern. Die gezeigten Fotos und deren Farben dienen ausschliesslich zur ungefähren Information. Es ist ausschließlich der italienische Text verbindlich, die Übersetzungen dienen lediglich der vereinfachten Lesbarkeit. Es wird empfohlen, vor dem Erwerb der Artikel dieses Katalogs die Verkaufsbedingungen, die technischen Eigenschaften und Anweisungen in der gültigen Preisliste nachzusehen.

**E\_Caimi Brevetti S.p.A.** se reserva, a su indiscutible juicio, el derecho a modificar sin previo aviso los materiales de construcción, las características técnicas y estéticas, así como las medidas de los productos del presente catalogo, donde las imágenes y los colores son meramente indicativos. El texto auténtico es exclusivamente lo en idioma italiano, las traducciones tienen el único propósito de simplificar la lectura. Antes de comprar los productos ilustrados en este catálogo, consulten las condiciones de venta, las características técnicas y las advertencias indicadas en la lista de precios en vigor.

PROGETTO GRAFICO

Factory Prime

FOTOGRAFIE

Interno20

Raoul Iacometti

Carola Merello

Andrea Pacino

STAMPA

Geca

COPYRIGHT

Caimi Brevetti SpA 2021

ARCHIVIO FOTOGRAFICO

Caimi Brevetti SpA



CAIMI BREVETTI S.p.A. - Via Brodolini, 25/27 - 20834 Nova Milanese - MB - Italy - tel. 0362 49101

Ufficio vendite Italia: tel. 0362 491001 - fax 0362 491060 - e-mail: vendite.italia@caimi.com

Export department: tel. (+39) 0362 491002 - fax (+39) 0362 491061 - e-mail: export.dept@caimi.com

www.caimi.com

