



RECEPTION

EDISON







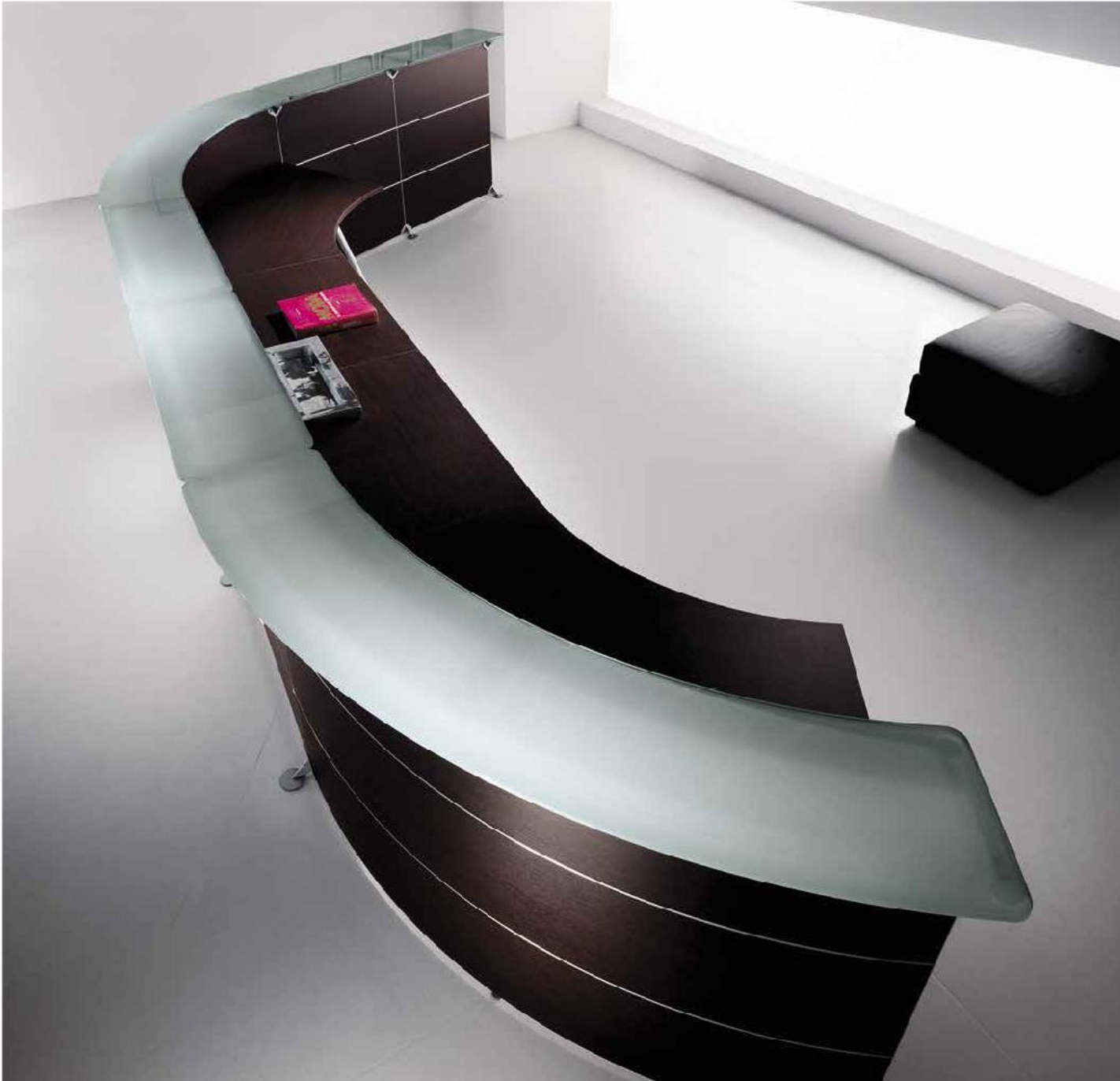

EDISON RECEPTION



Dare il benvenuto con stile:
il luogo diventa espressione
di classe, buon gusto e
accoglienza senza mai essere
invadente.

EDISON RECEPTION



Capace di “abbracciare”,
la *Reception* Della Rovere
stimola l’incontro.

EDISON RECEPTION



Abbinamenti diversi per
creare situazioni inedite che
sappiano esprimere eleganza
e unire materiali tecnologici
alla poesia del legno.

EDISON RECEPTION

Sobrietà, qualità, praticità: questi i tratti distintivi della collezione Della Rovere

Edison.

Edison è moderna e in melaminico



EDISON RECEPTION



Edison è una linea direzionale,
forza di indiscussa qualità
disegnata dall'architetto

Fabio Gigli

EDISON RECEPTION



Le reception *Edison* catturano la
forza del movimento,
richiamando la filosofia di
aziende dinamiche e aperte a
nuove sfide.

EDISON RECEPTION



Un perfetto biglietto da visita dato da un design sofisticato e versatile dove meccanismi e incastri ingegnosi rendono facile l'arredo in qualunque spazio.

EDISON RECEPTION



Il calore del legno e la modernità del vetro creano un contrasto unico, espressione di classe e armonia dell'insieme.

EDISON RECEPTION



I bisogni di ogni cliente sono soddisfatti dalla profondità di gamma, dei materiali e dei colori.

EDISON RECEPTION



Tutte le reception *Edison* sono
compatibili con le
Librerie UNI di Della Rovere.

EDISON RECEPTION



La *Reception* può essere personalizzata con scritte e loghi aziendali in plexiglass o in acciaio.



EDISON RECEPTION

Caratteristiche della Collezione

Caratteristiche della collezione



- Design Moderno
- Profondità di gamma
- Struttura composta da pannelli verticali curvi e lineari nobilitati con decorativi, e top in cristallo
- Piani di lavoro nobilitati legno
- Gambe e staffe metalliche
- Raccordi a 90°, 60°, 45°
- Elementi hospitality lineari e curvi a 60°
- Finiture nelle essenze noce, mogano, acero, alluminio, bianco e rovere scuro



EDISON RECEPTION

Punti di Forza

Punti di Forza



- > Qualità
- > Modularità
- > Versatilità
- > Completamento della struttura della reception con i mobili per l'archiviazione
- > Personalizzazione



EDISON RECEPTION

Caratteristiche tecniche

Elementi



45°

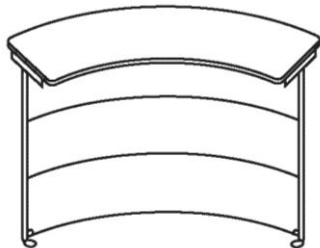

60°

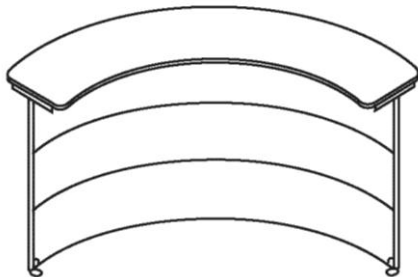

Elementi

Descrizione

- Dritto
- Curvo 45°
- Curvo 60°

Materiali

Nobilitato legno

Colori

Alluminio

Bianco

Acciaio

Rovere scuro

Top

Vetro bianco satinato







Piani di lavoro

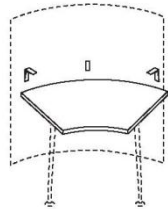
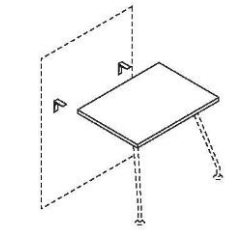

45°

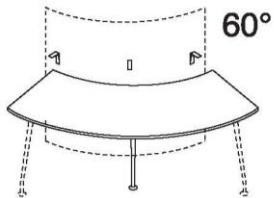

60°

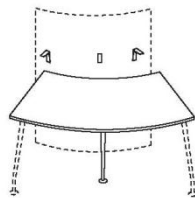

45°

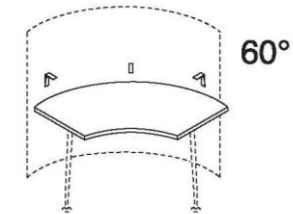

60°

Piani di lavoro

Descrizione

- Dritto
- Curvo 45° interno ed esterno
- Curvo 60° interno ed esterno

Spessore

mm 3 o 2,5

Materiali

Nobilitato legno

Colori

Alluminio

Bianco

Acero

Rovere scuro

Piani per raccordo

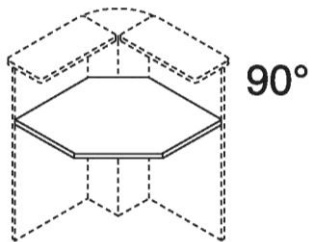
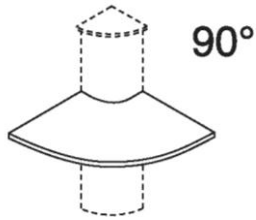

Piani per raccordo

Descrizione	- 90° - 90° interno	
Spessore	mm 3 o 2,5	
Materiali	Nobilitato legno	
Colori	Alluminio	Bianco
	Acero	Rovere scuro

Elemento hospitality

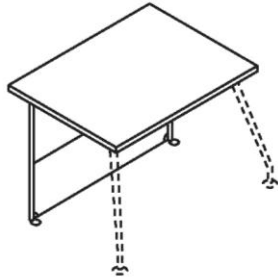

60°

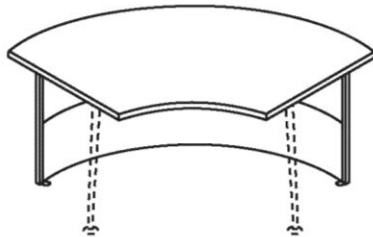

Elemento hospitality

Descrizione

- Dritto
- a 60° interno

Spessore

mm 3 o 2,5

Materiali

Nobilitato legno

Colori

Alluminio

Bianco

Acciaio

Rovere scuro



Elemento hospitality



Sistema di aggancio dei pannelli

Avviene con **staffe in metallo** che fungono da piedino e da supporto per i top.

Queste sono le uniche staffe valide per tutte le reception Edison.





Personalizzazione



Tipologia A superficie disponibile 70 X 20 cm



Tipologia B 45° superficie disponibile 100 X 20 cm



Tipologia C 45° superficie disponibile 100 X 20 cm



Tipologia D 60° superficie disponibile 140 X 20 cm



Tipologia E 45° superficie disponibile 140 X 20 cm



Soluzioni proposte

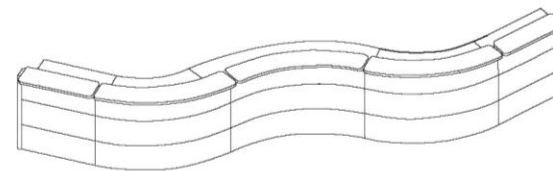
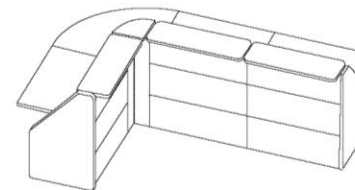
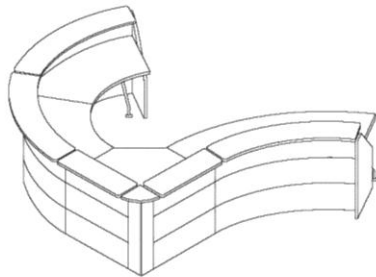
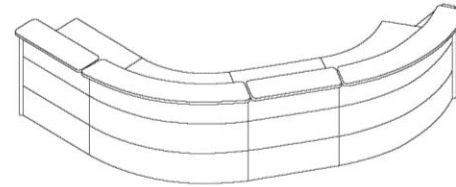
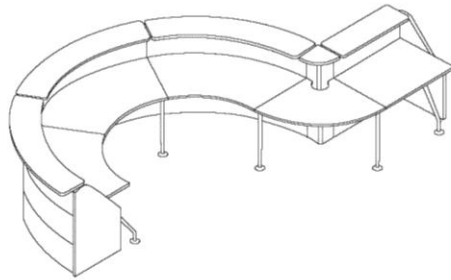
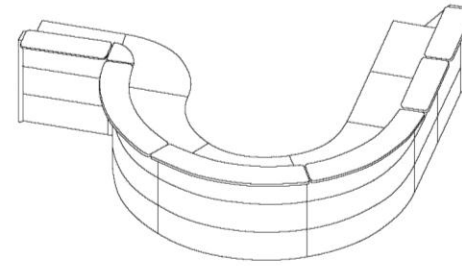
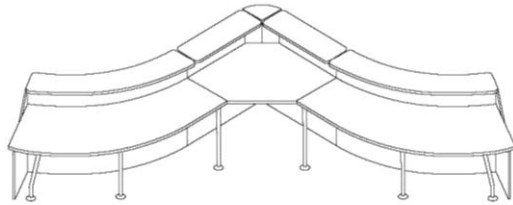



EDISON RECEPTION

Come ordinare

Come ordinare

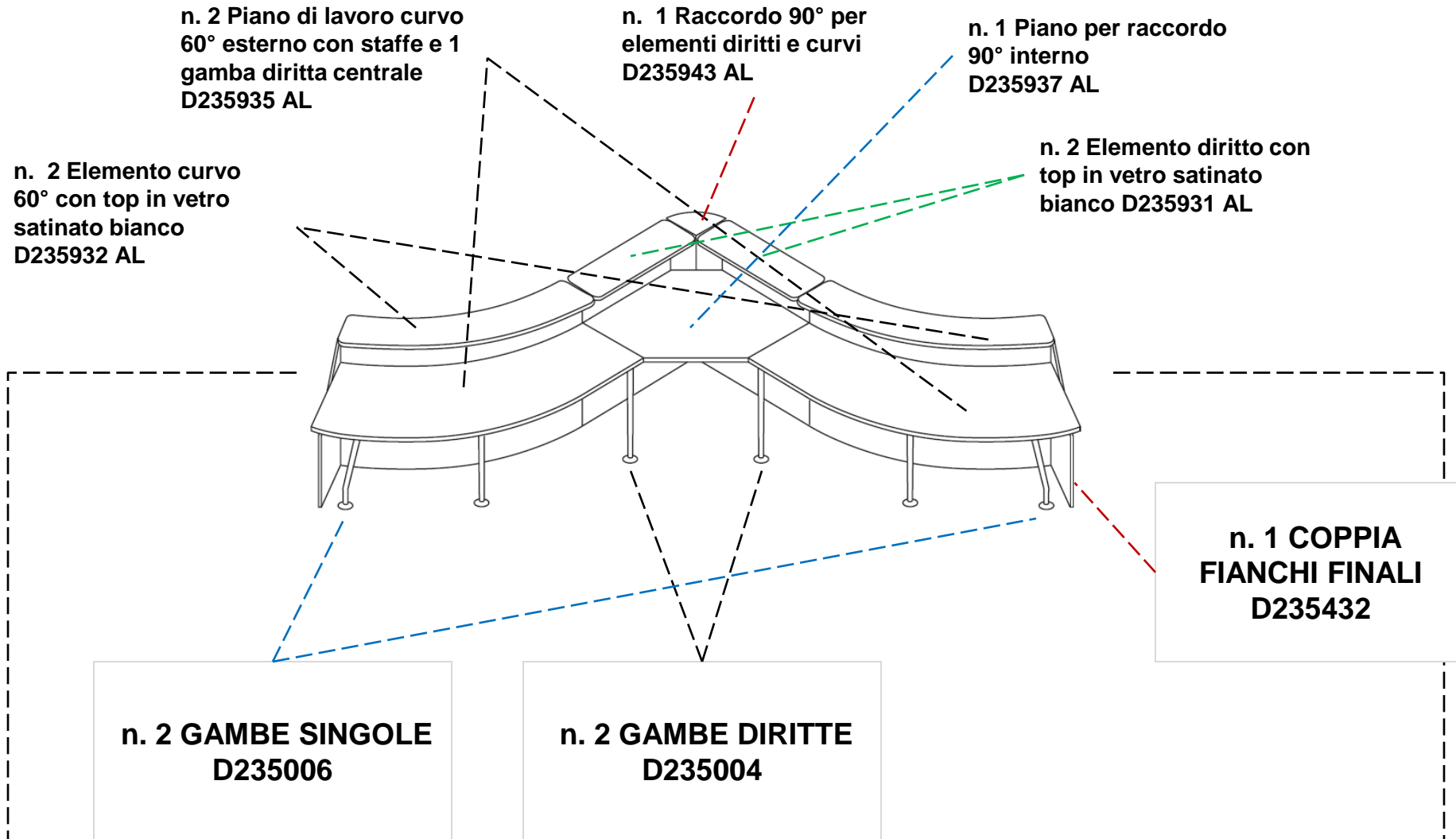

I fianchi di finitura laterali sono opzionali.
Anche quando ci sono i fianchi laterali vanno montate le gambe in alluminio.

Come ordinare

**n. 1 Ferramenta
terminale reception D
235983**

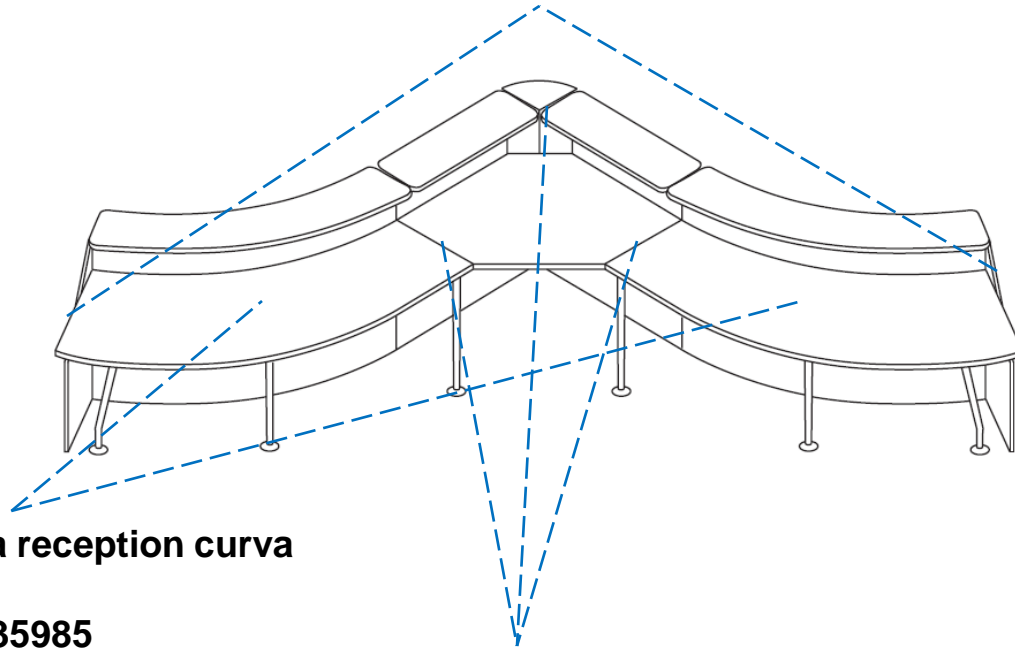

n. 2 Ferramenta reception curva

D 235985

**n. 3 Ferramenta intermedia reception
D 235984**